

Overview

This is a seven day white water canoe trip down Quebec's Batican River, from Thursday July 1st to Thursday July 8th. Upon our departure late Wednesday, we will drive to Joliette in Quebec and camp for the night at a commercial campground. The next morning we will take the train from Joliette to the put-in point. We will have a short paddle to our first campsite on Saturday night. Thereafter we will work our way down the river with plenty of time to play in the rapids. In addition to our canoes, we will be bringing a kayak playboat along. Take out on the Thursday at Rousseau, with a train ride back to Joliette, returning to Merrickville Thursday evening. The river is located partially in the territory of the Portneuf Wildlife Reserve.

Participants

Name	Type	Canoe	Position	PFD
Hamill, Stew	Adult	1	Stern	Salus M/L w/QRB & pigtail
Yates, Allan	Adult	1	Bow	Salus M/L w/QRB
Catton, Ben	Youth	2	Stern	Salus M/L w/QRB & pigtail
Gale, Calvin	Youth	3	Stern	Salus S/M
Gale, Jennifer	Youth	4	Bow	Salus M/L
Jackman, Gregory	Youth	3	Bow	Salus S/M
McKay, Alex	Youth	5	Stern	Salus S/M w/QRB & pigtail
Taylor, Max	Youth	4	Stern	Salus S/M
Szalai, Adam	Youth	2	Bow	Salus M/L

Finances

Item	Budget	Actual	Notes
Mileage Truck & Trailer - Allan, 2x300km @ \$0.30/km	\$180		
Mileage Van - Stew, 2x300km @ \$0.20/km	\$120		
Food - (\$10/pp/day), 7 days, 10 people	\$700		
Train	\$795	\$684	10 people, 5 canoes
Portneuf Wildlife Reserve camping fee	\$?	\$109	\$8.25/adult/night, \$4/child/night
Camping Belle-Marée fee	\$80		Estimate
Friday morning breakfast at Tim Hortons			
Lunch on train heading out			
Supper during drive home			
Contingency	\$200		
Total	\$2,075		
Total per Venturer (8)	\$259		
Total advertised fee per Venturer	\$325		
Deposit	\$100		
Final payment	\$225		

Schedule

Packing equipment and food at tractor trailer and Allan's house on Wednesday evening.

Thursday July 1st

Meet at Allan's house at 5:00pm for a 6:00pm departure. Eat supper before departure or bring brown bag from home.

Drive to Joliette, 3 ½ hours, 300km; arrive ~10:00pm. Highway 416 south, highway 401 west into highway 20, highway 540 north to highway 40 west, exit 122 to highway 31/131 north, then right on route 131, left on Boulevard Antonio-Barrette, right on Rang Sainte-Julie, and left on Number 4. Utilise radios for inter-vehicle communication.

Camp at Camping Belle-Marée (reservation made).

Potentially view Canada Day fireworks somewhere.

Friday July 2nd

Breakfast at Tim Hortons (included in fee).

Train departs Joliette at 9:53am; must arrive at the station by 8:50am. This is the Montreal to Jonquière route. Reservation file numbers QEH818 and QEH915.

Lunch purchased on the train (included in fee); each person must supply their own beverage.

Train arrives at Pearl Lake put-in at 2:04pm; could be 30-60 minutes late.

Start canoeing at 3:00pm

Paddle upstream about 500m to campsite at km 170.

Arrive at campsite at 4:00pm.

Saturday July 3rd

Camp at km 147 (confluence of Rivière aux Éclairs), paddle distance 23 km.

Sunday July 4th

Keep out long sleeved shirts/trousers for bushwacking trail.

At km 141 on river right, hike up hill to fire lookout tower; approximately 1 km each way. Trail and/or tower may no longer exist.

Camp at km 131 (confluence of Rivière Jeannotte), paddle distance 16 km.

Adjacent play rapids with CIV slide, and tail end of Rivière Jeannotte.

Section "Gates of Hell"

Monday July 5th

Camp at km 116 (alternative at km 121), paddle distance 15 km. Port Neuf reservation # 5693834.

Section "Gates of Hell"

Tuesday July 6th

Camp at km 109, paddle distance 7 km. Port Neuf reservation # 5693834.

Potential play rapids just downstream of campsite.

Wednesday July 7th

Camp at km 89 (confluence of Rivière-à-Pierre), paddle distance 20 km.

Thursday July 8th

Depart campsite at 8:00am.

Paddle distance 4 km, with a 200m CII, a 200m CIII, and an SIII/IV.

Arrive at the take-out at 11:00am.

Train departs Rousseau at 1:00pm, and arrives at Joliette at 3:54pm

Depart Joliette at 5:00pm. Drive to Merrickville, 3 ½ hours.

Supper purchased during drive home (included in fee).

Arrive Merrickville approximately 9:00pm.

Call parents upon arrival in Merrickville or drop kids off at their homes.

Clean kit and distribute for drying.

Batiscan River

Total river length	85 km	
Total mandatory portage length	xx m	(longest possible portage is xx m)
Total rapid length	17 km	(20% of river length)
Number of mandatory portages	1	
Number of optional portages	x	(will depend on water level)

Benchmarks for the flow reference are for the section between Isle à la Croix and the Barrier Batiscan (the section called *The Gates of Hell*):

- The lower limit is around 15 m³/s. At this rate the river is calmer, but still pleasant.
- The river is probably the most difficult around of 70-80 m³/s.
- Around 100 m³/s, there aren't very many remaining rocks; rapids are comprised mostly of large waves.

Expect about 25% of the marked campsites, especially those grade 'C' or lower, to not exist. This river is travelled for the water, not for the quality of the campsites.

The class of the rapids depends on the water level, and some class IV may only be class III for us. On the maps, in an 'SIV', the 'S' is French for Ledge. I.e. a class IV ledge.

	Batiscan River			Noire River		Lièvre River	
Class	Number	Length	Notes	Number	Length	Number	Length
I	28	6,566m	Includes I/II	26	1,852m	30	3,529m
II	25	5,943m	Includes II/III	20	2,375m	34	6,824m
III	18	3,396m	Includes III/IV	4	345m	22	7,353m
IV	2	283m				9	1,941m
V	1	50m					

SPOT Satellite Messenger Usage and Response Protocol

Approximately once a day we will use it to send a "Check In" message. The result will be an email similar to the one below being sent to yourselves and all the parents. It includes a link to our location on Google maps. Not receiving a report from us is NOT an indication of a problem. There could be many reasons why no message is being sent or received.

We can also utilise the device to signal that we need help or we have an emergency. The protocol is as follows:

Need Help

We will utilise this function if we cannot move from our present location and require extraction. This could be an equipment, medical, or other problem. An email is sent to Bob and Cheryl only. They would contact the OPP Communication Centre at 888-310-1122 and pass on our location with a request for assistance. It is expected that they will contact their counterparts in Quebec or Trenton Search & Rescue as they see fit. A response time of 24-48 hours would be desired.

Emergency (911)

We will utilise this function if we have a life or death situation or a serious medical problem. The SPOT response centre will contact emergency services directly. They will contact Bob (613-269-2521) and/or Cheryl (613-269-3074) if they have any questions.

Participant Qualifications

Name	Whitewater Courses	ORCA	Swimmer	First Aid	Boat Rescue	River Rescue
Hamill, Stew	None	No	Yes	Standard	No	Yes
Yates, Allan	Canoe I/II/III, Kayak I	MW 1	Yes	Standard	Yes	Yes
Catton, Ben	Canoe I/II/III, Kayak I/II	MW 2	Bronze Cross	No	No	No
Gale, Calvin	Canoe I/II	No	Yes	No	No	No
Gale, Jennifer	Canoe I/II/III, Kayak I	MW 1	Yes	No	No	No
Jackman, Gregory	Canoe I/II	No	Yes	No	No	No
McKay, Alex	Canoe I/II/III, Kayak I/II	MW 1	Yes	No	No	Yes
Szalai, Adam	Canoe I/II, Kayak I	No	Yes	Yes	No	No
Taylor, Max	Canoe I/II	No	Yes	Yes	No	No

References

Cartes Plein Air	www.cartespleinair.org/Canot/05/BatiscanLeduc2009.pdf
Water Gauge	www.cehq.gouv.qc.ca/suivihydro/graphique.asp?NoStation=050304
Camping Belle-Marée	www.guidecamping.ca/bellemaree/
Rapid video	www.youtube.com/watch?v=q18y7rJukmM
Via Rail	www.viarail.ca
Portneuf Wildlife Reserve	www.sepaq.com/rf/por/
My Osis Portneuf	www.myosis.ca/fi_jeannotte_portneuf.htm
Water Level	www.gaetanlord.ca/info_debit/GraphLevel.cgi?Riviere=Batiscan%3APortes+de+l%27enfer

PFD Sizing

Salus Kayak Guide	Chest Size	Quantity	
		Available	Required
Small / Medium (S/M)	32" - 40"	8	5
Medium / Large (M/L)	36" - 44"	4	5
Large / Xtra Large	40" - 48"	None	N/A
Xtra / 2Xtra Large	44" - 52"	None	N/A

Issued Personal Equipment

A PFD and helmet will be issued to every person at the beginning of the trip. These will be marked with the person's name. They are responsible for them throughout the entire trip. Each person will select a paddle of their preferred size. At least one spare of each size paddle will be brought.

Vehicles

Vehicle	# of Seats (incl. driver)	Make	Model	Colour	License Plate
Allan	7	GMC	Yukon XL	Pewter	AKFA 929
Stew	5	Buick	LeSabre		BCCZ 332
Canoe Trailer		EZ Loader		Grey	D76 30J

Access (Train)

The train is a great way to access the Batiscan River. Typically, the departure is from Rivière-à-Pierre, at 12:49pm in early afternoon on Monday, Wednesday and Friday. The train is often late, typically 30 to 60 minutes, so you must be on time, but not to count with certainty on the time of launching.

It is possible to book train tickets for passengers only via the website of VIA Rail. By calling directly to Maryse Perron, who works at the station at Rivière-à-Pierre, two birds can be killed with one stone 1) to book tickets for passengers, and 2) secure a place the train for canoes. Maryse Perron will take the necessary steps to ensure there is enough room in the baggage cars, by adding cars as needed.

These steps must be made at least 4 days in advance for 3 boats or less, and one week in advance for 4 boats and more, or to mitigate the risk that too many paddlers also reserve at the last minute.

Maryse Perron knows the approximate time of descent by canoe between the different stations and the barrier Batiscan. She has a river map in hand and knows where and how to get cars to the take out point. Very nice and pleasant. (418) 323-2117 or marysep22@hotmail.com.

Equipment and Food Packing

All equipment, such as tents and pot sets, will have to be opened up to check their contents are complete. Each person will pick a paddle of their preferred size; at least one spare of each size will be brought as well (total of four spares). Food items, where possible (e.g. UHT milk), will be frozen to provide refrigeration of the meat through the first three days of the trip. All meat will be frozen to ensure maximum longevity. Matches will be stored in two watertight plastic containers.

Equipment Storage

Each canoe will carry the personal rucksack of the two paddlers, along with a maximum of two barrels and a spare paddle. Any fishing rods will be lashed alongside the spare paddle for protection. The two barrels containing the first aid kits and repair kits will be marked with a green cross sticker and stored in separate canoes. For quick access in an emergency, one pruning saw will be in the thwart bag on Ben/Adam's canoe, and one in the day dry sack on Allan/Stew's canoe. Common camping equipment will be stored in two 60 litre barrels. Food will be stored across a maximum of six 30 litre barrels. Tent poles will be fastened to the outside of a rucksack. Light weight equipment (such as backpacking stoves) will be used where possible. Spare paddles will be bungeed to the thwarts. The pin kit will be stored in one of the large equipment barrels to keep it from getting waterlogged.

Lining

It is intended that the canoes be lined down some of the rapids that are too dangerous to run. 25' of floating rope is used bow and stern, carabinered to the grab loops. This rope also functions as a painter when needed. When not in use, the rope is stowed in the day dry sacks in the canoes to prevent any potential entanglement.

Portneuf Wildlife Reserve

229 Rue du Lac Vert

P.O. Box 10

Rivière-à-Pierre, Quebec

G0A 3A0

Telephone: (418) 323-2021

Fax: (418) 323-2159

Safety Precautions

- A properly fitting personal floatation device will be worn when on the water.
- A helmet will be worn when near rapids.
- Personal floatation devices and helmets will be securely fastened when worn.
- When scouting rapids, each person will wear their PFD and helmet, and may bring their paddle for support. The throw bags from each canoe will be brought in the event a rescue is required.
- No participants have mortal allergies.
- All rapids will be scouted before running.
- Strongest paddlers will run rapid first and act as a safety boat for the remaining canoes.
- Option to portage any rapid for any person not comfortable running a given rapid.
- Safety equipment (pin kit, first aid kits, and repair kits) carried on two separate canoes.
- A safety boat will always be used when swimming rapids or running rapids.
- Venturers will be sleeping in tents separate from the leaders.
- All drinking water will be purified using chlorine bleach, at the ratio of eight drops per gallon (two drops per litre) and let sit for 30 minutes.
- All swimming (without PFDs) to be supervised by an adult.
- No food in personal rucksacks.
- Each canoe to be equipped with for/aft float bags, bow/stern grab loops, a bailer, an extra paddle, and a 70' throw rope.
- Food barrels to be stored well away from camp.
- Emergency exit from the trip is the railway that parallels most of the river. The train stations are identified on the maps as are the days/times on which the train will pass.
- River Rescue training taken by Allan, Stew, and Alex.
- All participating Venturers have a minimum of two weekends of whitewater training, including the Canoe II course, offered through Paddler Co-op and the Venturer Advisors Forum.
- All participating Venturers will have attended a River Safety course.
- Rucksacks and equipment will be tightly secured to the canoes so equipment is not lost or snagged if a canoe flips.
- A SPOT Satellite Personal Messenger will be taken. Daily check-in messages will be sent, with all Venturer participant parents along with Bob Sargent and Cheryl Yates being recipients. Help and emergency messages can also be sent with Bob and Cheryl being the contacts.

Hospital

The closest hospitals are located in Saint-Raymond and Quebec City.

Maps

We have a river map from Cartes Plein Air showing all the rapids. Copies of the relevant maps are at the end of this document. The maps have been customized with our planned campsites and other informative notes. Five plastic laminated copies of these maps will be brought on the trip. These maps will be carried in waterproof map cases. We will also carry a Quebec provincial road map.

Equipment Colour for Search and Rescue

Item	Quantity	Colour	Notes
Canoes	4	Red	
Creek kayak	1	Red	
Playboat kayak	1	Green	
Tents	2	Gold	Venturers and Allan
Tent	1	?	Stew

From Jim Michaud (reference www.mycr.com/SectionForums/viewtopic.php?f=115&t=6186)

Two years ago a friend and I paddled the Batiscan from Lac Édouard to where the Batiscan comes close to the paved road near the town of Rousseau. We did the trip during the third week of May and paddled solo whitewater canoes.

We started paddling as soon as we got off the train and camped the first night near where the train crosses the Batiscan. At this point the river is mostly flat water paddling all the way to Rivière Édares. When the river came close to the railroad I was amazed by all the Moose hunting tree stands. Some of them were little temporary things but many of them were huge luxury rooms complete with glass windows and stoves. From Rivière Édares to the Rivère Jeanotte we started to pick up several easy rapids that were a bit on the scratchy side.

When we arrived at the Rivère Jeanotte things changed. The Jeanotte almost doubled the volume of the Batiscan and we hit a few very short but very intense rapids. We ran all of the rapids but it took awhile to scout out safe routes, especially the one at the junction of the Jeanotte. This was our last night on the river and we camped on the Cross Island near Miquick. This is where the commercial raft trips start from. There was plenty of room to camp and there was no-one else around.

The last day was the grand finale. The rapids were big, pushy and long. We were both experienced whitewater enthusiasts so we handled the rapids without difficulty except that my friend did swim once. The one rapid to watch out for is the "Gates of Hell" which is a little ways downstream from where the railroad tracks pull away from the river for the last time. When the river narrows stay far to river left. From upstream it looks like you want to go right but the right side ends up going over a tall ledge into a monster hole. Several soldiers died there during the 1970s when their raft flipped (they weren't wearing life jackets). The ledge on the far left is only a foot or two high and no big deal. Below the Gates of Hell there are still several very neat rapids and one of them is where my friend swam.

Before going on the trip I was corresponding with someone who was also planning to do the same trip but they were going to do it in a tandem canoe. After he returned he emailed me to say that they broke one of the gunnels of their canoe and one of them broke a finger in the process. I told him beforehand that I didn't think that it was the place for a tandem canoe but he thought otherwise. A tandem canoe would be fine if you took out at Club Jacques-Cartier but below there I would still recommend a solo whitewater canoe.

From *Broken Finger* above

"Normal" summer water levels should be ok, the rapids will be bouldery requiring more maneuvers but you will probably avoid the massive waves which are what gave me trouble. In retrospect I would have been fine in my tandem if I'd had the spray cover which I now own.

The fact is that my boat and body damage might not have happened if I hadn't read my map wrong and blindly ran a class IV drop thinking it was only class II (this is the rapid just downstream of where the Jeanotte joins in). Take heed of Jim's warning on the Gates of Hell rapid, as he says the hole on river right is a serious killer, at the time of my trip even the ledge on the left was more than I felt comfortable running but it was a relatively easy line around.

From David Milot (reference <http://www.myccr.com/SectionForums/viewtopic.php?t=8879>)

I ran it several times at different period of the year... Late June is certainly the best time!

The last time we did it, I brought my brother with whom I paddle duo. He never ran whitewater before... he certainly enjoyed the ride. Also a friend of mine was kayaking for the third time only. He was able to run almost all rapids without major problem.

At mid-high level, the river is certainly comparable to the Madawaska Kanu Center section in difficulty... which I did last year mid-august (but lower level). You will need to scout most of the rapids if it's your first time...but here is the same advice for all first time rivers!!!

If you are considering being 4-5 days on the river, I suggest you starting at Pearl Lake. The first two days are easier and will help get in symbiosis with the river before attempting the Hell's gate section (continuous class 3)

At my point of view, it isn't the hell's gate section the most difficult part (except the big class 5 ledge) "Les Trois-Roches rapids" is one the most technical rapids. Fore sure the confluence of the Jeanotte-Batiscan is a tough one too, but portages and scouting is quit easy.

From Henk (reference <http://www.boatwerks.net/boaterboard3/viewtopic.php?f=1&t=10208>)

Reference trip of June 3-6, 2010.

The river itself was o.k. Most of the rapids were very small with lots of rocks showing. I like big water better most of the time but this trip was certainly more technical. On the wider sections of the river it was sometimes touch and go if there was enough water to float the boat but mostly we could pick out the deeper water channels. We started from Jaques Cartier station (shack in the bush) and had a good first day down. The second day started out nice but then around 11:00 the rain started and did not let up all day. We had planned on paddling 30km and then picking one of 3 choices for campsites. We were unable to find any of them. We knew exactly where we were on the map but the campsites seemed to have been overgrown. There were one or two spots with waist high grass which did not seem very appealing in the rain and 10 degrees C. We decided to paddle another 10km to the take out and spent the night in a nice warm hotel instead. It was a good thing as the rain did not let up all night or most of the next day. This is a very scenic river with lots of high cliffs and even a sort of cave under a huge rock on the right side of the river that acts like a refrigerator. You can feel in on the river about 30-40' away from the bank. Hopefully you will get a spike in the levels before you go as this seems to happen at some point each season and maybe you can open up some more campsites for us for the next time we go :)

From David (reference <http://www.myccr.com/SectionForums/viewtopic.php?f=115&t=13338>)

We had a real great time on both rivers. The Éclairs offers better scenery than the Batiscan at my point of view. Lots or rapids (we were at high level on both). The two falls are spectacular. We camped for our first night at marked campsite some 3km upriver from the confluence of the Batiscan (there is now a cabin there. We even met the owner who let us camped there.) We camped for the second night at the Jeanotte junction (picnic table, toilet, fire pit) great site close to the big rapid. For our 3rd night we used the campsite on the left high bank at the Laurent Train station (picnic table too at this site) lots of bugs! The shuttle is very easy to do, the road in the ZEC de la Rivière-Blanche was freshly regrind. My friend's dad took our car back to the takeout. The water was perfect... we made only 2 portages at the 2 falls on the Éclairs, lining 5 times on the Batiscan (Beudet rapid km145, S4-5 km 134, Jeanotte junction km133, class5 km 133, S5 km110). We had a great time running the water slide (R4) following the Jeanotte, Les Rouleaux were amazing (8-10 ft pyramidal waves) we even did it twice... Hells' gate.... what to say!!! So 4 days-3 nights... smile on our face for the entire trip... great ww route!!!

VIA Rail

A discount is available for groups of ten or more people. These tickets are fully refundable, but must be paid at least 30 days in advance of departure.

Supersaver fares incur a \$20 service charge in each direction for refunds or changes. There are a limited number of seats available at this price.

The Montreal to Jonquière route is all economy class. Seat reservation not available.

Snacks are provided in an at your seat aisle service.

Must arrive at the station one hour before train departure for loading baggage.

Canoes and kayaks are \$50 plus taxes, per train, or equivalent to fare paid by passenger if less (excluding children). Minimum fare per train is \$20 plus tax.

"Parking at Joliette is dead easy, safe and free. You unload, carry it around the siding (100m) and then on to the boxcar. The station is vintage; complete with old posters and slot back benches."

Person	From Ahuntsic		From Joliette		
	Supersaver	Group	Supersaver	Group	Seat Sale
Adult (18+)	\$66.60	\$77.88	\$53.05	\$60.95	\$45.15
Senior (60+)		\$69.98		\$54.18	\$42.89
Student (12-17)	\$66.60	\$60.95	\$53.05	\$47.41	\$38.38
Canoe		\$77.88		\$60.95	\$45.15
Total (1 adult, 1 senior, 8 students, 5 canoes)		\$1,032.76		\$799.16	\$684.03

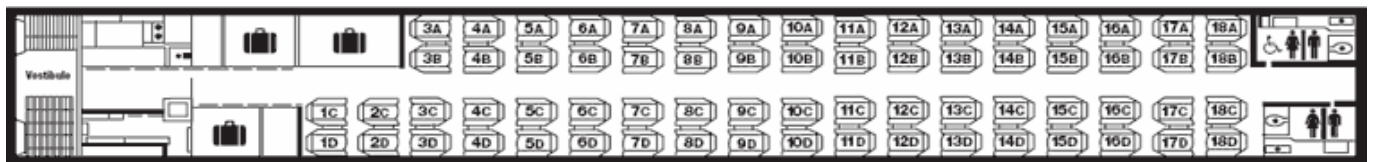

Train Menu**BEVERAGES**

Hot Beverages*, Naya Spring Water, Fruit Juices, Vegetable Juice, Soft Drinks, 2% Natrel Milk, 1% Natrel Chocolate Milk	2⁰⁰
Smoothies: blueberry or mango	3⁰⁰

*VIA Rail Canada is proud to serve fair trade hot beverages.

SNACKS / LIGHT MEALS

Pringles Potato Chips, Assorted Chips, Assorted Chocolate Bars, Pop Corn, Muffins, Danish, Yogurt, Apple Strudel, Assorted Cereal, Brownies	2⁰⁰
Bagel and Cream Cheese, Hot Dog, Tuna Snack and Crackers, Hummus and Crackers, Grilled Cheese and Bacon Sandwich, Cashews	3⁰⁰
Campbell's Chunky Soups	3²⁵
Double Cheeseburger, Hot Entrées, Submarine	5⁰⁰
Sandwich Combo (includes sandwich, cheese, vegetables and dip), Cheese Plate	6⁰⁰

ALCOHOLIC BEVERAGES

Canadian Beers, Bistro Mundo Wines, Red or White	6⁰⁰
Scotch, Rye Whisky, Rum, Vodka, Gin, Smirnoff Caesar, Smirnoff Vodka Ice, Brandy, Guinness Imported Beer, Grand Marnier	7⁰⁰
Cognac	8⁰⁰
VIA Rail Canada Playing Cards	3⁵⁰

All sales taxes included.

Personal Kit List

- Sleeping bag
- Sleeping pad (optional)
- Torch
- Headlamp (recommended)
- Change of clothes (several)
- Change of footwear
- Trousers
- Long sleeved shirt
- Swim suit
- Towel
- Sweater or sweat shirt
- Sweat pants
- Rain jacket
- Rain pants (optional)
- Pyjamas
- Pillow (optional)
- Wash kit: tooth brush, tooth paste, soap, shampoo, chapstick, etc.
- Shampoo/body wash, no-rinse (astronaut) (optional)
- Mess kit: plate, bowl, cup, knife, fork, spoon in mesh bag
- Water bottle w/carabiner, 2
- Sunscreen
- Insect repellent
- Hat / Baseball cap
- Toque (optional)
- Kleenex (optional)
- Gloves, bicycle/paddling/neoprene/Mechanix/etc (optional)
- Sunglasses w/strap (optional)
- Water shoes and/or neoprene booties (optional)
- Pocket knife (optional)
- Sheath knife (optional)
- Camera (optional)
- Multi-tool (optional)
- Compass (optional)
- Fishing rod & tackle (optional)
- GPS (optional)
- Wetsuit (optional)
- Bug shirt/jacket (optional)
- Paddling jacket (optional)
- Technical long underwear (optional)

All personal kit must be packed in a rucksack or canoe pack. No dangling or loose items are permitted. The rucksack must have a luggage tag with the Venturer's name, address, and telephone number as these will be checked into the baggage car on the train. Anything the Venturer would like during the train journey should be carried separately.

Everything must be completely waterproof using either dry sack(s) or garbage bag(s). The rucksacks will be sitting in water all day. If garbage bags are used, they must be resealed, not discarded every day. Any discarded garbage bags must be packed out by the participant.

Quick drying materials such as polypropylene and polyester fleece are recommended. Wet feet are a given. Open toed sandals are not permitted in the canoe. Plan for one pair of wet shoes for canoeing, and one pair of dry shoes for camp. Glasses should be secured with a strap.

Electronic devices/iPods/telephones/etc are not permitted.

Menu**Thursday**

Dinner
Brown bag or eat before departure

Friday

Breakfast
Purchase at Tim Hortons
Lunch
Purchase on train, bring water bottles
Dinner
Sausages (2/pp), grilled vegetables & potatoes

Saturday

Lunch
Wraps (2pp), sliced ham (2-3pw), lettuce, mustard, cheese, mayonnaise
Dinner
Tacos, ground beef (3lbs), lettuce, tortilla soft shells (large, 2pp), sour cream, onions, taco seasoning, salsa, cheese, carrot sticks

Sunday

Lunch
Wraps (2pp), roast beef (2-3pw), lettuce, horse radish, cheese, mayonnaise
Dinner
Chili, shredded cheese, garlic bannock biscuits

Monday

Lunch
Wraps (2pp), turkey (2-3pw), lettuce, cheese, mayonnaise
Dinner
Pizza, pita bread (2pp), pepperoni (2 sticks), cheese (mozzarella), green peppers, onions, pizza sauce

Tuesday

Lunch
Pepperoni (2 sticks), crackers, cheese
Dinner
Fettuccini Alfredo, chicken flakes, garlic bannock biscuits, parmesan cheese

Wednesday

Lunch
Peanut butter & jam sandwiches, wraps/English muffins/bagels
Dinner
Macaroni & cheese (PC white cheddar, 1/2 box pp), Salmon croquettes

Stew is allergic to gluten. He will bring his own bagels and bread, and we will pack extra salmon, chicken, and carrot sticks.

Menu (continued)**Thursday**

Lunch
Leftovers
Dinner
Purchase during drive home

Breakfasts

Oatmeal, variety pack
Lucky Charms
Frosted Flakes
Rice Krispies
Bagels
English Muffins
Peanut butter
Jam
Pop tarts
Cream cheese

Snacks

Granola bars
Peanut M&Ms
Marshmallows
Caramels
Beef jerky
Apples
Nuts & dried fruit
Montreal steak spice

Drinks

Fresh milk (first morning)
Tetra Pak milk (remaining mornings)
Juice crystals (iced tea)
Hot chocolate
Coffee

Desserts

Backpacker's Pantry Wicked Good Brownies
Mud Pies
Chocolate cookies
Toffee cookies
Black Forest cake

Grocery List

Item	Quantity	Status	Store	Notes
Milk, 3.5%	1 litre			
Milk, 3.5%, UHT	6 litres			1/day + 1 extra
Granola bars, Sweet & Salty	1 large box		Costco	
Granola bars, chocolate covered	1 large box		Costco	
Peanut M&Ms	1 large bag		Costco	
Marshmallows	1 regular bag	Have		
Caramels	36			Toffee cookies
Beef jerky	2 large pkgs		Costco	
Cream cheese, spreadable	2 containers			
Hot chocolate	18 pkgs	Have		
Pop tarts	1 box w/3 boxes			
Lucky Charms	1 large box		Costco	
Rice Krispies	1 large box		Costco	
Frosted Flakes	1 large box		Costco	
Bagels, white	12			
English muffins	18			
Peanut butter, crunch, Kraft	1 large jar			
Jam, strawberry	1 large jar			
Wicked Good Brownies	1	Have	MEC	Backpackers Pantry
Juice crystals, Iced Tea	2 kg	Have		
Pepperoni	4 long sticks			
Crackers, Ritz	1 large box			
Cheese, cheddar	3 large blocks (900g)		Costco	1 extra for Stew
Cheese, mozzarella	1 large block (900g)		Costco	
Roast beef, sliced	1 pkg		Costco	
Turkey, sliced	2 pkgs		Costco	
Ham, sliced	1 pkg		Costco	
Lettuce, iceberg	3 heads			
Mayonnaise, squeeze bottle	1			
Mustard, squeeze bottle	1	Have		
Horseradish	1			
Sausages	18			
Grilled vegetables & potatoes	3 packages			
Chicken, flaked	3 cans			2 extra for Stew
Fettuccini noodles	24oz (680g)			
Tortillas, soft, large	54			
Taco seasoning	3 packets			
Salsa	1 bottle			
Beef, ground	3 lbs			
Macaroni & Cheese, PC White Cheddar	4 boxes			
Pitas w/pocket	16		Costco	
Pizza sauce	1 bottle			
Green peppers	2			
Apples, red	1 bag			
Apples, green	2 bags			

Item	Quantity	Status	Store	Notes
Vegetable oil	1 small bottle	Have		
Butter	1 lb			
Corn flakes	2 cups			Toffee cookies
Eggs	6	Have		
Tinfoil	1			
Chili	1		Ben	
Creamers	3		Work	
Chocolate cake mix	1 box			
Cherry pie filling	1 can			
Chocolate frosting	1 package			
Dream Whip	1 box			
Bannock, just add water	2 boxes			
Coffee		Have		
Garlic butter, ¼ stick	2			
Salmon	4 - 7 ½ oz (203g) cans			2 extra for Stew
Nuts & dried fruit			Stew	
Zip-Loc bags, large	2 boxes			
Ingredients for Mud Pies				
Ingredients for Chocolate Cookies				
Ingredients for Toffee Cookies				
Ingredients for Salmon Croquets				
Parmesan cheese	1 cup			
Ingredients for Fettuccini Alfredo				
Carrot sticks	1 bag			
Sour cream	250 mL			

Recipes

Mud Pies

2	Cups	White sugar
½	Cup	Milk
½	Cup	Shortening
5	Tablespoons	Cocoa
½	Teaspoon	Salt
1	Teaspoon	Vanilla extract
3	Cups	Quick cooking oats
1	Cup	Fine coconut

Mix first set of ingredients in a large saucepan. Bring to a boil, and remove from heat. Add second set of ingredients. Mix well. Cool a little and drop by teaspoon onto wax paper, and allow to harden for 1-2 hours.

Chocolate Cookies

1	Cup	Semi-sweet chocolate chips
1	Cup	Butterscotch chips
1 ¼	Cups	Granola

Melt chips over low heat, then remove from heat and stir in granola. Drop by spoonfuls on wax paper.

Toffee Cookies

36		Caramels
3	Tablespoons	Cream (light)
2	Cups	Cornflakes
1	Cup	Rice Krispies
½	Cup	Coconut

Put caramels and cream in large heavy saucepan over low heat to melt. Add remaining ingredients. Stir to coat. Drop by spoonfuls onto greased surface. Leave to harden. Makes about 3 ½ dozen.

Salmon Croquets

2 - 7 ½	oz	Salmon, drained, reserve juice
1		Egg
½	Teaspoon	Salt
1/8	Teaspoon	Pepper
½	Teaspoon	Worcestershire sauce
¼	Cup	Reserved juice
½	Cup	Flour
1	Tablespoon	Baking powder

Combine first six ingredients in bowl. Mix well. Add flour and baking powder. Stir together. Drop by rounded spoonfuls into hot 375 °F (180 °C) fat. Brown completely. Makes 16 croquettes.

Garlic bannock tea Biscuits

Get the Oven started and start mixing up the following:

Pour a very small amount of bannock mix onto a plate or bowl to dust your hands to prevent sticking when you get to the hands on stage

1 package of (Just add water) bannock mix. Add the water to the bag following the instructions (conveniently marked on the bag). Mix right in the bag No need to get the hands all covered and sticky bannock (yet). Roll the mixed bannock into small balls and flatten slightly (use the small amount of mix you poured out to dust your hands or it could get sticky)

Oven should be ready now.

Chop a quarter stick of garlic butter in half and toss into the Oven and let it dissolve. Add the prepped bannock biscuits to the pan... Don't worry about if they are too close; fill the pan. Cover and cook until they are done (same as a cake, insert a fork, it should come out clean)

Black Forest Cake

Ingredients

- 1 box chocolate cake mix
- 1 can cherry pie filling
- 1 package of chocolate frosting
- 1 box of "Dream Whip" (like Nutra-Whip, but comes in powdered form)

Instructions:

1. Mix chocolate cake mix as per box. You will need to divide batter into 2 portions and cook each portion separately. (2 layers of cake) Set aside to cool.
2. Mix the chocolate frosting as per the package.
3. Dream Whip - put powder contents of pouch into a Tupperware container, add a rounded tablespoon of skim milk powder and the indicated amount of liquid, in the form of the coldest water you can find all in container with lid. Shake vigorously for 2-4 minutes.
4. On a plate, put one cake layer down, spread with cherry-surprise pie filling, put other chocolate cake layer on. Frost whole cake with chocolate icing, put a blob of cherry-surprise filling on center top, and decorate with the white Dream Whip.

Fettuccini Alfredo

- 2 cups of whipping cream
- 1 cup of butter
- 1 cup of parmesan cheese
- Parsley
- 24oz (680g) fettuccine noodles (3oz/person)

Cook and drain noodles.

Melt butter; add whipping cream and cheese just before pouring over noodles. Cooking the butter/cream/cheese for only a minute.

Camping Equipment @ Trailer

Tent, MEC Nimbus 5
 Tent footprint, MEC Nimbus 5
 Tarp, 12'x16' (screen shelter ground sheet)
 Tent pegs, sand, 8
 Tarp, lightweight, 15'x15'
 Barrel, 60 litre, w/harness, 4
 Barrel, 30 litre, w/harness, 4
 Dry bag, 10 litre, red, 3 (day use in canoe)
 Dry bag, 20 litre, yellow, 1 (day use in canoe)
 Screen room, 15'x15'
 Tent pegs for screen room

Kitchen Equipment @ Trailer

Pot set, MSR, large, w/ 2 pot grippers
 Frying pan, 2
 Fuel bottle, MSR, 650mL, 6
 Stove, MSR Simmerlite, 2
 Stove, MSR Dragonfly
 Fuel pump, MSR Simmerlite, 2
 Fuel pump, MSR Dragonfly
 Water containers, collapsible, 2
 Utensil rollup
 Spoon, serving, nylon, 2
 Spoon, serving, slotted, nylon
 Spoon, wooden, 2
 Spatula spreader, 2
 Spatula, nylon, 2
 Knife, sharp, w/cover, 2
 Tin opener
 Whisk, small
 Tongs
 Cheese grater/slicer
 Colander, collapsible
 Egg carrier, 6 eggs
 Grill (for cooking pizza over fire)
 Cutting board
 Stove top toaster

Camping Equipment w/Allan

Hammock, Hennessey, 2
 Shovel, folding
 Newspaper
 Pump, air, manual
 Matches, 100, water tight box, 2
 Torch, butane, mini, 2
 Toilet paper, 4 rolls
 Garbage bags, 4
 Playing cards, 2
 Saw, folding
 Hatchet, Gerber Sport Axe, 35cm
 Paracord, 100', 3
 Single cup coffee maker
 Coffee filters, #2, 25
 Bleach bottle w/eye dropper, 2
 Bleach, extra bottle
 Welding gloves
 First aid kit, large, 2
 Repair kit, 2
 Weather forecast
 Bungee cords
 SPOT (borrow from VAF)

Pin Kit

Saw, pruning, 2
 Line Across bag
 Rope, static, 150'
 Webbing, tubular, 30', 3
 Sling, nylon, double, 2
 Carabiner, locking, D, 10
 Pulley, prusik minding, 5mm, 2
 Prusik loop, 5mm, 2

Kitchen Equipment w/Allan

Pot, large
 Tinfoil
 Paper towel
 Wax paper
 Outback oven
 Soap, biodegradable
 Scrubbing pad, non-metallic, 3M
 Scrubbing sponge, 2
 Pouch, window, large, 2
 Vegetable oil
 Tea towel, 2

Paddling Equipment

Dolphin, inflatable
 Canoe, Canyon, 4
 Kayak, creek (Jackson Villain, rental from Paddle Shack)
 Kayak, Jackson Fun, green
 Kayak skirt, 2
 Paddle, kayak, 3
 Paddle, canoe, 12 (includes 1 spare per canoe)
 PFD, Salus Guide, medium/large, w/whistle & knife, 5
 PFD, Salus Guide, small/medium, w/whistle & knife, 4
 Quick release belt, 4
 Pig Tail, 3
 Floatation bags, 4 pairs
 Bailer w/rope, 4
 Throw bags, Northwater, 1/4", 70', 5
 Maps, river, waterproof, 5 sets
 Map case, waterproof, w/clips & bungees, 4
 Thwart bag, w/map case
 Rope, floating, 1/4", 25', w/carabiner, 10 (for painters & lining)
 Rope, floating, 1/4", 25', 5 (for lashing gear in canoes)

Allan's Extra Kit

Multi-tool
 Thermometer
 Watch
 Camera (fully charged), w/8G SD card
 Camera spare battery, 3 (fully charged)
 Camera SD card, 4G, spare
 Mobile telephone (fully charged)
 Physical fitness forms
 Tent, 2 man (MEC Gemini), w/poles, 6 pegs, ground sheet
 Pelican camera case, w/lanyard & carabiner
 Shaver (fully charged)
 Contact lens solution
 Spare contacts
 Thermarest chair
 Notebook & pencil
 Compass
 Carabiner, 4
 Flashlight, spare
 Headlamp, spare
 Trip plan, 2

Allan's Extra Kit for Truck

Road map, Quebec
 Road map, Montreal
 CDs
 Mobile telephone charger
 Inverter
 Electrical octopus
 Shaver cord
 Air compressor, 12V (flat tire)
 Truck garbage container w/bags
 Radio, VHF, 2
 Radio chargers
 GPS

For Train Journey

Book
 Camera
 Water bottle, full
 Train tickets

Outback Oven Configuration

Convection Done
Aluminized fabric dome concentrates heat around baking pan and vents excess hot air out top.

Thermometer
Viewed through vent hole to monitor baking temperature.

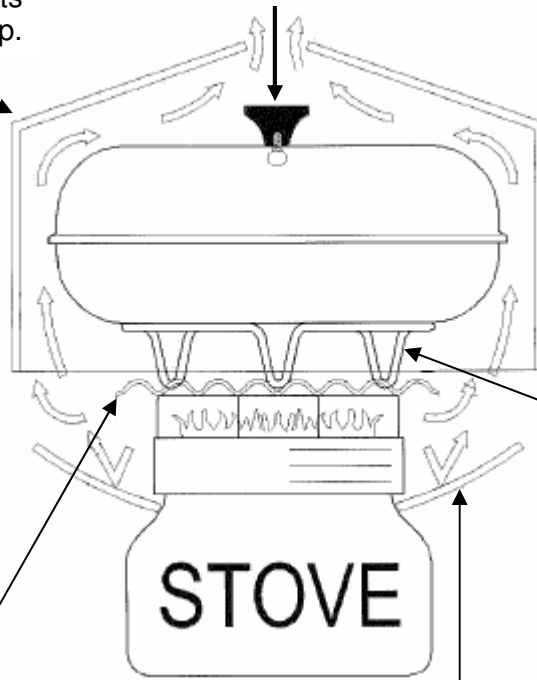

Scorch Buster
Ribbed stainless steel disk disperses heat and prevents flames from coming in contact with baking pan.

Reflector Collar
Aluminum collar directs heat upwards, boosting efficiency and shielding stove from overheating.

Riser Bar
Snaps into Scorch Buster and raises baking pan above heat to prevent scorching.

First Aid Kit

Band-Aids, Elastoplast
 SAM splint
 SAM splint, finger
 Diphenhydramine (antihistamine), 12
 Diotame (stomach), 12
 Loperamine (anti-diarrheal), 12
 Glucose (hypoglycemia)
 Almag (antacid), 12
 Gauze pad, 4"x4", 50
 Ibuprofen
 Acetaminophen
 Solarcaine
 Bandage, elastic, 3"
 Bandage, cohesive, 2"
 Gauze roll, 4
 Cohesive bandage
 Ex-lax or mineral oil
 Ointment, triple antibiotic (anti-infective), 12
 Tape, Durapore, 1"
 Safety pins
 Needle
 EMT shears, 7.5"
 Triangular bandage
 Alcohol wipes
 Hand sanitiser
 Tweezers, tick removal
 Tweezers, splinter
 Benzoin swabs, 8
 Eye drops
 Ophthalmic wash
 Anti-fungal cream
 Hydrocortisone cream, 1% (anti-inflammatory)
 Moleskin
 Iodine
 Antibacterial soap
 Thermometer, oral
 Razor, disposable
 Cotton swabs
 Tongue depressors
 Flash cards, Wilderness Medical
 Blist-O-Ban; 2 small, 2 medium, 2 large
 Notebook
 Pen, 2
 Moleskin
 Magnifying glass
 Space blanket
 Rehydration salts, oral, CeraLyte 70, 2

First Aid Kit (continued)

Tegaderm
 Hypafix, dressing retention
 Tongue depressor
 Gloves, nitrile
 Scissors, O.R., sharp/sharp
 Scissors, nail
 Polymem medicated membrane dressing
 Dental module
 Hand sanitiser w/Benzalkonium Chloride
 Dermabond
 Steri-strips (wound closure)
 Butterfly closures
 Syringe, irrigation, 20cc, 18AWG
 Saline solution, 500mL
 Water Jel Burn Gel, 6
 Water Jel Burn Dressing, 2"x6"
 Water Jel Burn Dressing, 4"x4"
 Scalpel, #10
 Cold pack, 2

Dental Module

Oil of cloves
 Dental floss
 Dental mirror
 Temporary dental filling

Repair & Emergency Kit

Patch kit, float bag
 Patch kit, inflatable boat
 Patch kit, inflatable animals
 Patch kit, Thermarest
 Epoxy putty, ABS/Royalex
 Bolt, seat, w/nylock nuts & washers, 4
 Bolt, thwart/splash deck, w/nylock nuts & washers, 2
 Fibreglass repair kit
 Wire, galvanised, 0.041" (18 AWG)
 Screwdriver, multi
 Wrench, adjustable
 Scissors
 Seam sealer
 MSR Simmerlite Expedition Service Kit
 Tent pole repair sleeve
 Hacksaw, 6"
 Cable ties
 File
 Tear-Aid Patch Repair - Type A
 Tear-Aid Patch Repair - Type B (vinyl)
 Gear Aid Ultra Light Gear Repair Kit
 Gear Aid Tent Repair Kit Deluxe
 Alcohol pad, 10
 Shoe lace, 24"
 Cyalume, 12 hour, yellow, 2
 Thread, sewing
 Needles
 Buttons
 Velcro
 Fastex buckle
 Mirror, signal
 Matches, waterproof
 Candle
 Fire starter
 Cord lock
 Flashlight, mini

Repair & Emergency Kit (continued)

Twist ties
 Rubber bands
 Pins, safety, 5
 Pen, Rite-in-the-Rain
 Marker, Sharpie
 Garbage bag
 Ziploc bag, 2
 Epoxy, 5 minute
 Whistle, Fox40
 Webbing, 1", 4'
 Tape, electrical
 Tape, Gorilla
 Tape, flagging
 Pliers, locking
 Pliers, needle nose

Repair & Emergency Kit (Future)

Wire, stainless steel, 0.028" (21 AWG)
 Wire, stainless steel, 0.041" (18 AWG)
 Wire, stainless steel, braided
 Compass
 Flashlight, 2AA
 Drill
 Water purification tablets
 Sandpaper
 Multi-tool
 Paracord
 Clamp, small, 2
 Awl
 Fishing line
 Whetstone

Camping Belle-Marée

Rang Ste-Julie, Chemin n° 4
Notre-Dame-des-Prairies, Quebec
J6E 8Y6
(450) 756-2542

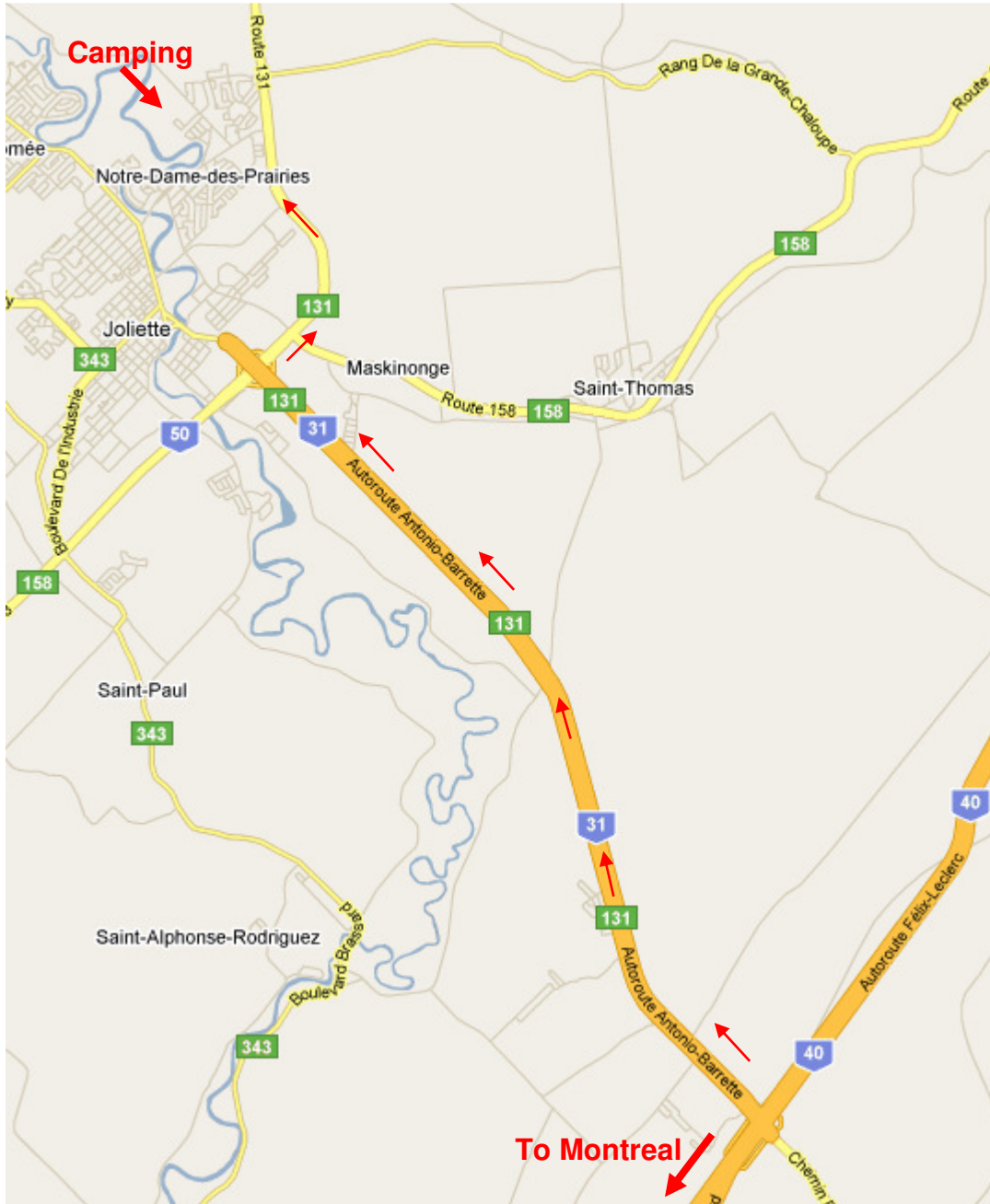

Joliette

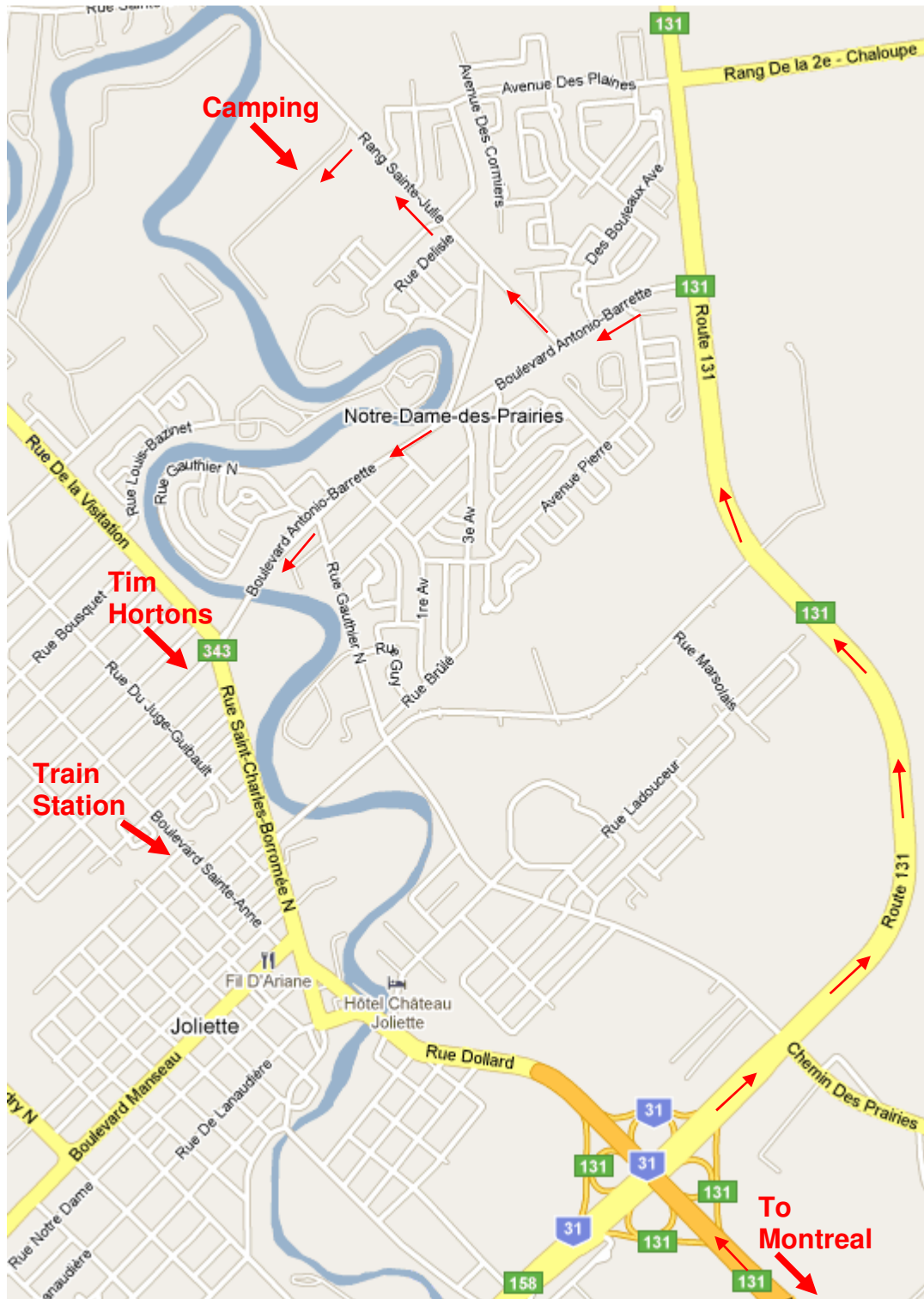

Joliette

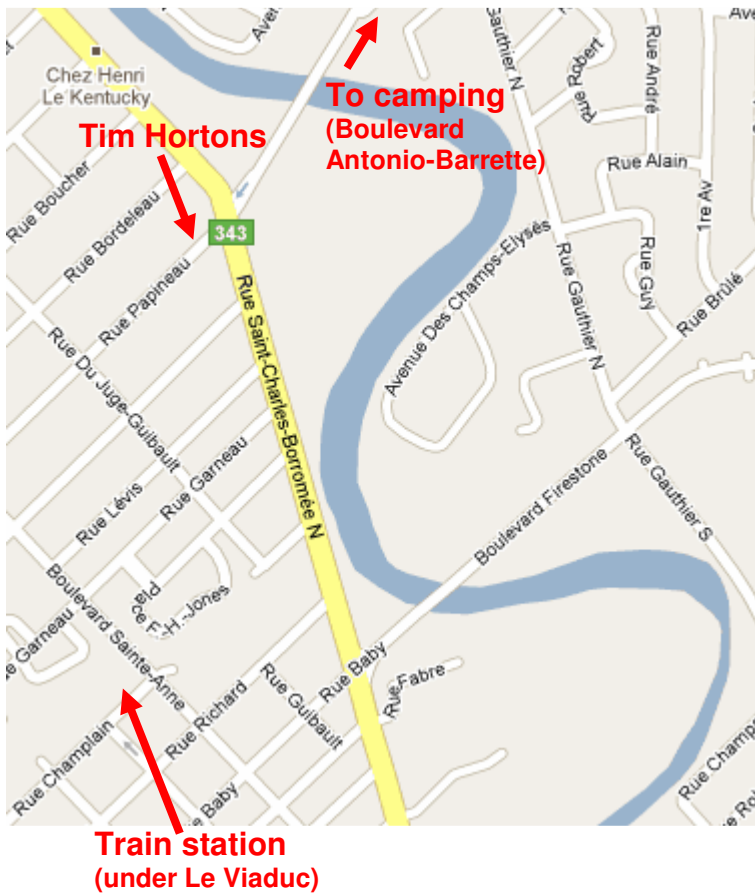
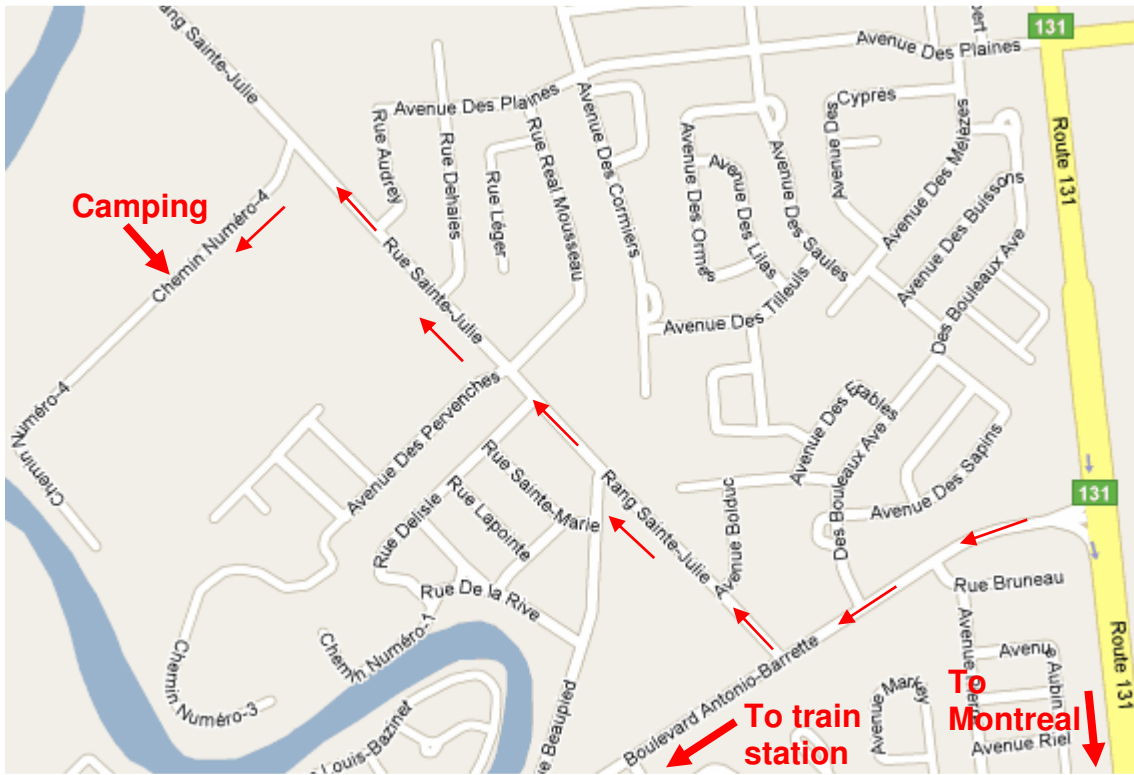

Joliette Train Station

380 Rue Champlain
Joliette, Quebec
JSE 2S1
(450) 759-3252



(c) Jean-Francois Brulotte
MovingWheels.Com
VIA Joliette station
Joliette, QC
July 14, 2004



(c) Jean-Francois Brulotte
MovingWheels.Com
VIA Joliette station
Joliette, QC
July 14, 2004

Train Journey (Montreal to Jonquière route)

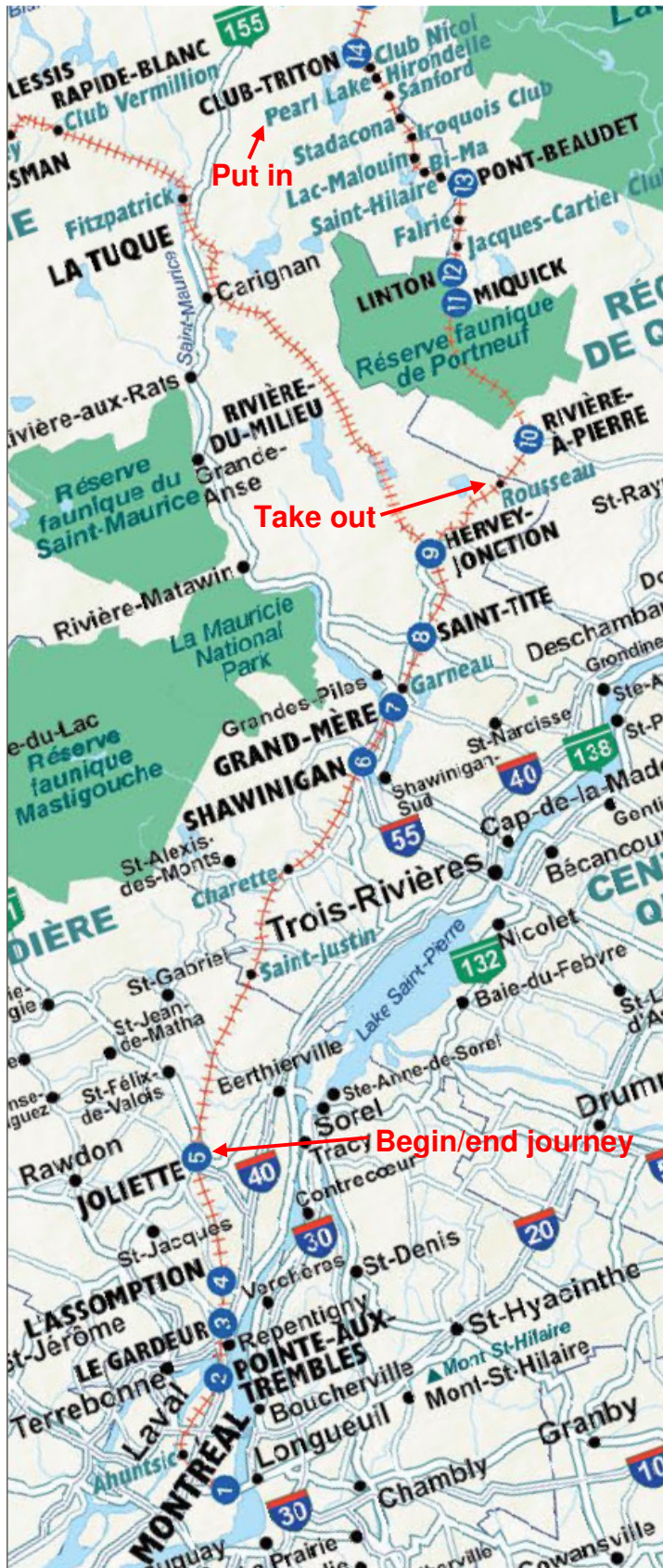

History of the Batiscan River (major train stops)

Station 10: Rivière-à-Pierre

Mile: 39.9 Population: 694

Founded in 1897, this village now exports granite around the world. It is also the gateway to the Portneuf Wildlife Reserve, created in 1968, that you will cross for the next 35 kilometres. This is where the 68-km-long Jacques-Cartier/Portneuf bicycle path starts. From mile 51.0 to 69.9, you travel alongside one of Québec's most beautiful white water rivers, the Batiscan. White water enthusiasts have nicknamed this place "hell's gates" for a particularly wild stretch of rapids, shoals and cascades.

Station 11: Miquick

Mile: 59.1

"Bear" in Algonquian. Many canoe and kayak expeditions depart from the campsite on the island across from it, Île-à-la-Croix.

Station 12: Linton

Mile: 61.9 Population: 32

From 1907 to 1949, Linton was the railway transfer point from Québec City to La Tuque. You will see the remains of the old bridge on the southwest side of the Batiscan, a few hundred metres to the north. This section of the river is magnificent and, if you look closely, you may see rock climbers on the majestic cliffs.

Station 13: Pont-Beaudet

Mile: 69.9

Former site of the Windsor Loghouse, headquarters of the company responsible for building the railway in 1886, Pont-Beaudet simply consisted of a farm, a general store and all the equipment needed to supply the workers.

Station 14: Club-Triton

Mile: 90.7

This station serves La Seigneurie du Triton, a 50-room hotel located in the forest, 4 km downstream from the river. In 1886, the engineer in charge of railway construction, A.L. Light, erected and founded the Triton Fish and Game Club here. The first Club House was built in 1897. Since then, many celebrities have visited it, including Winston Churchill and several American presidents. It now attracts numerous tourists from around the world. There are no roads or paths; it can only be reached by water, notably from the station. From here, you can also reach the Innusit Village, which offers stays in tipis in the very heart of the forest.

Station 15: Lac-Édouard

Mile: 95.3 Population: 155

The village was founded in 1885. The 28-km-long lake is the source of the Batiscan and Jeannotte rivers. In times gone by, this village had a sanatorium for people with tuberculosis. Today, like the many outfitters' lodges found here, it accommodates tourists who wish to make the most of the region's natural beauty.



Confluence of Batiscan and Jeannotte Rivers

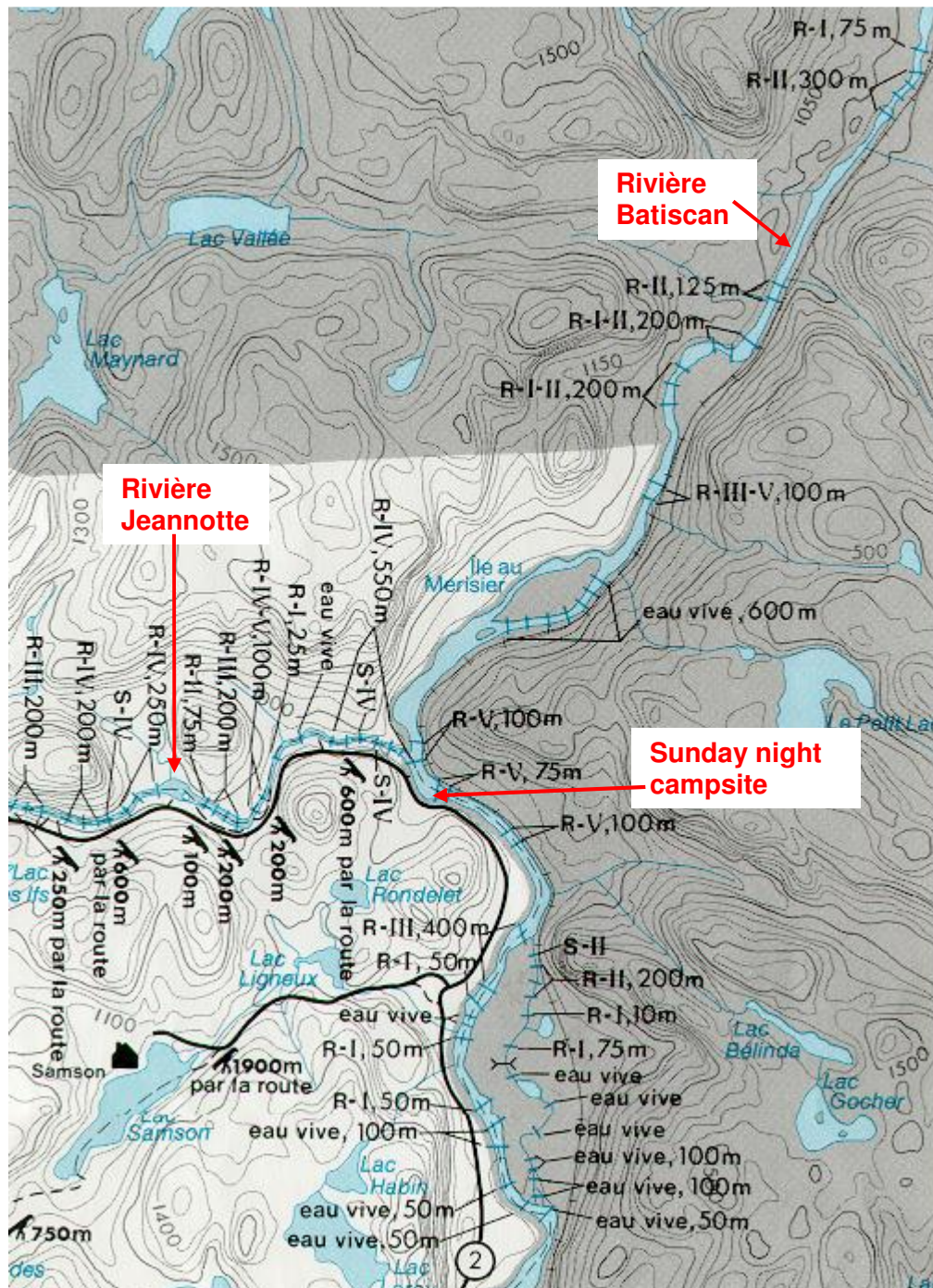

Île à la Croix

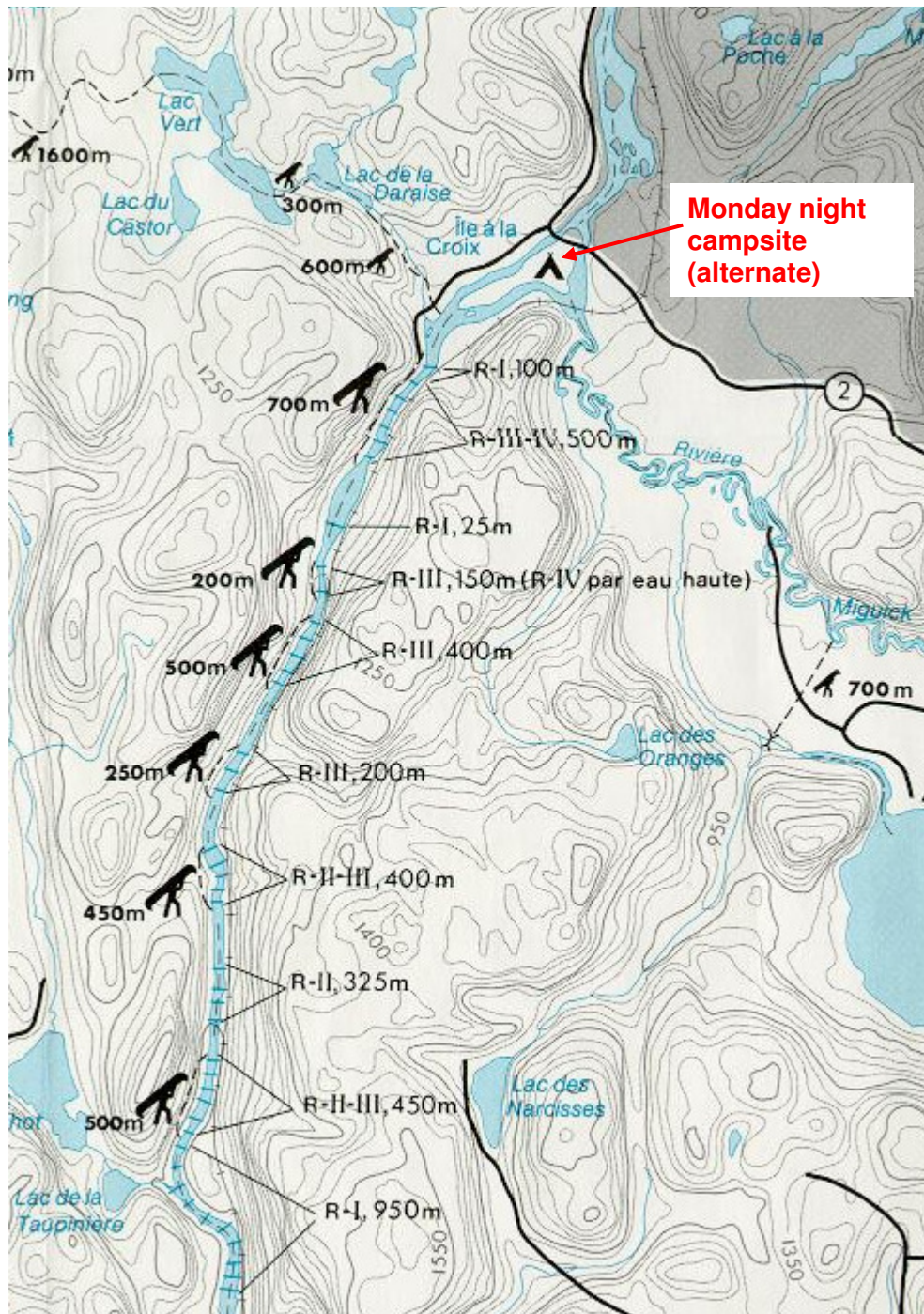

The Gates of Hell

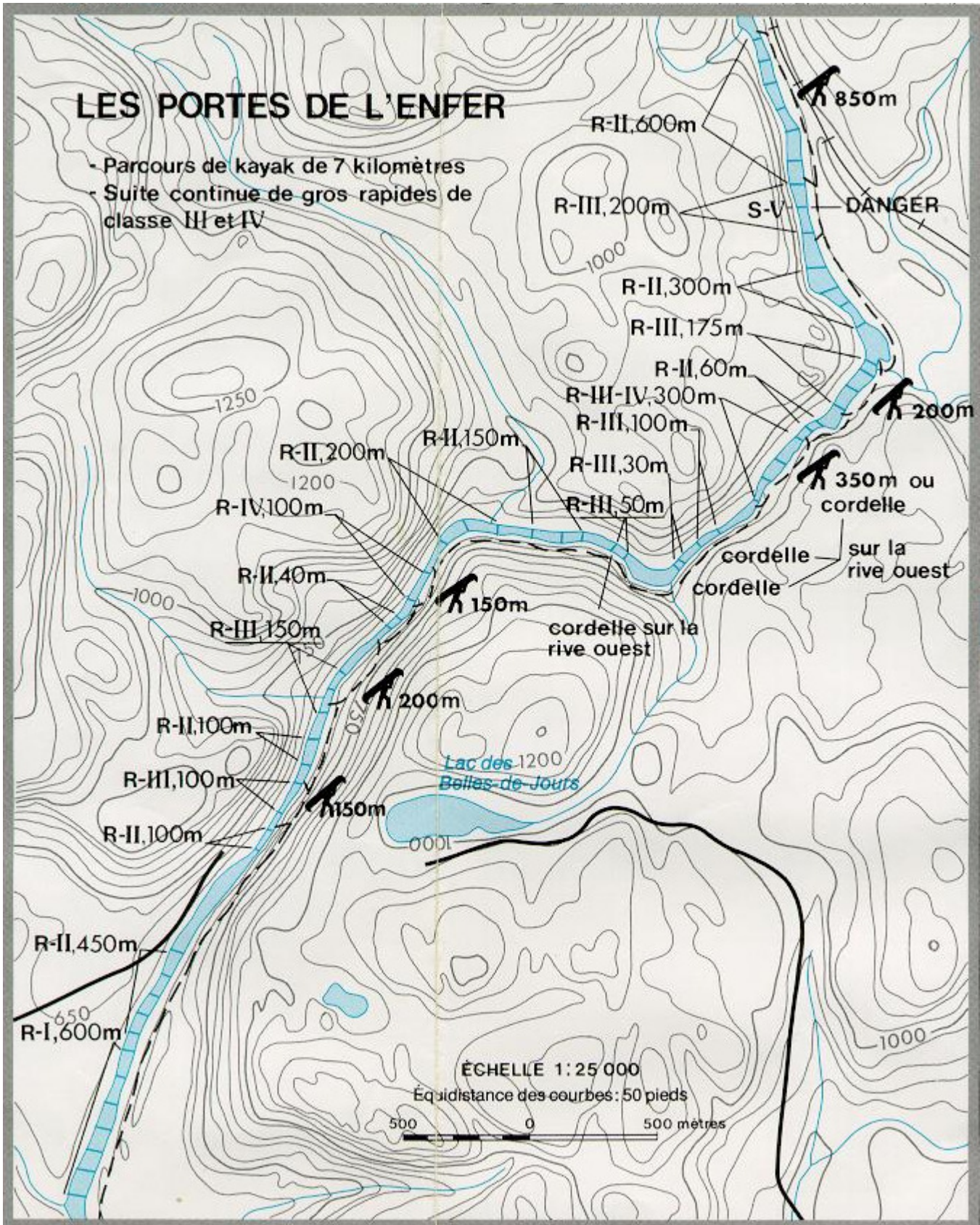

Portneuf Wildlife Reserve (North half)

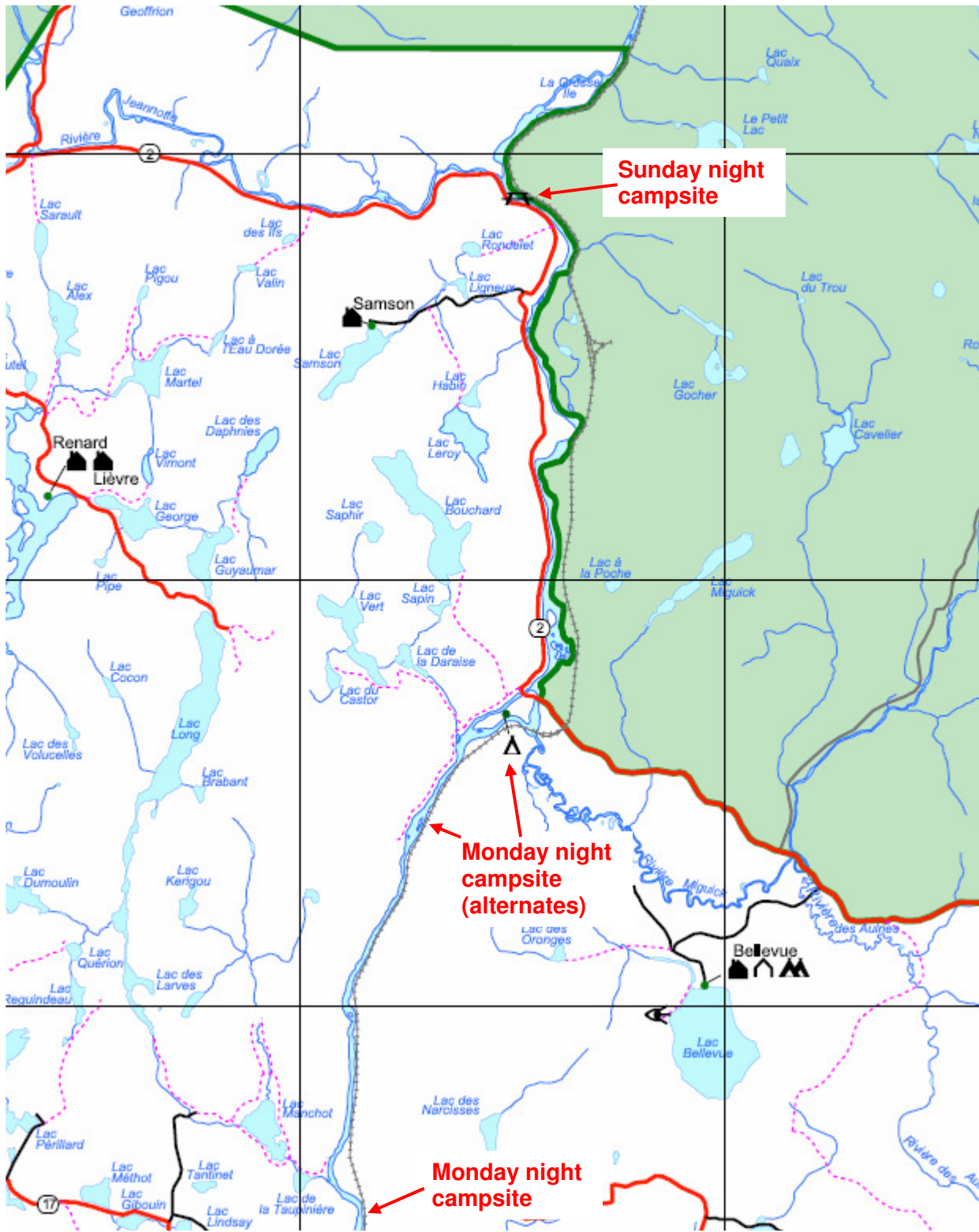

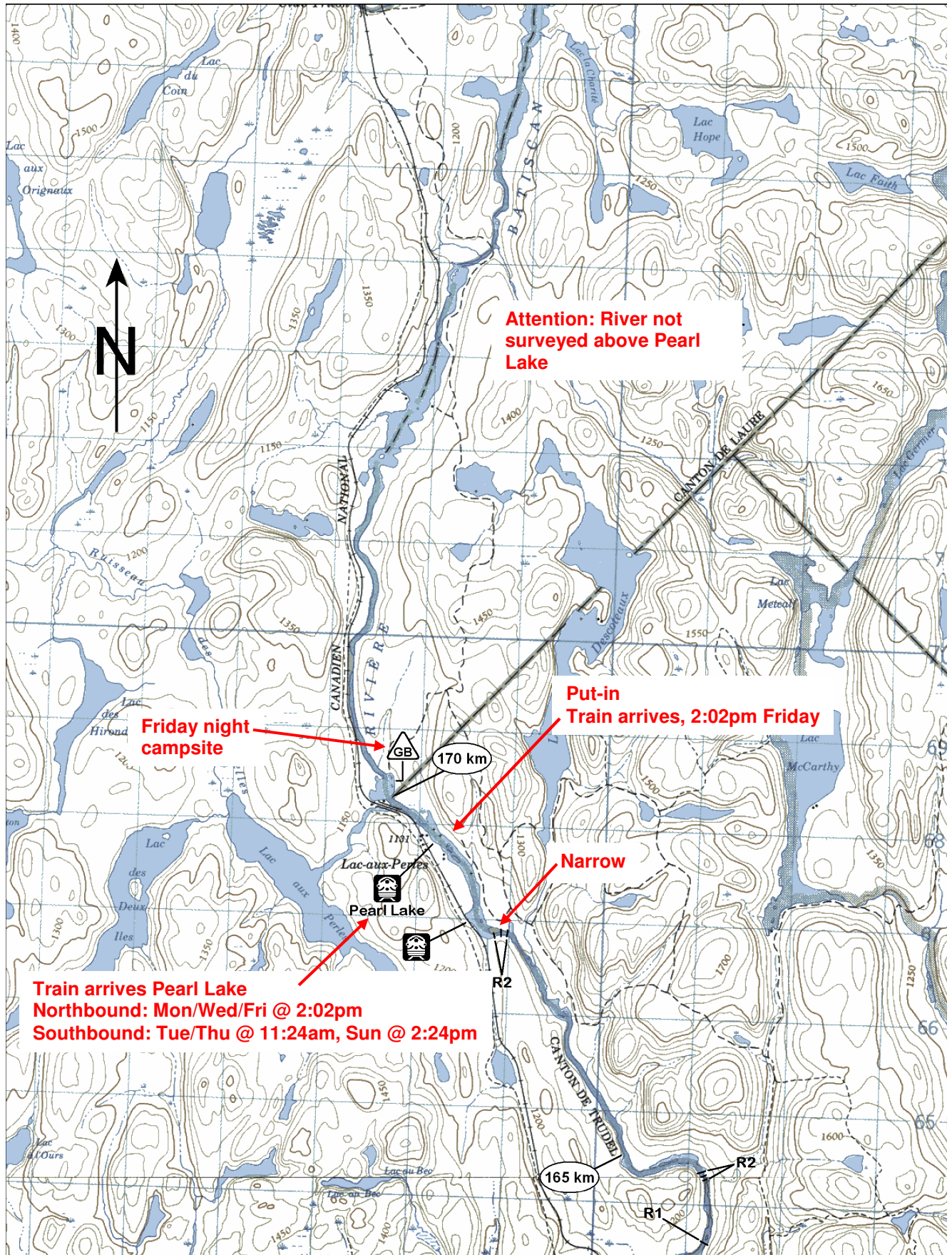

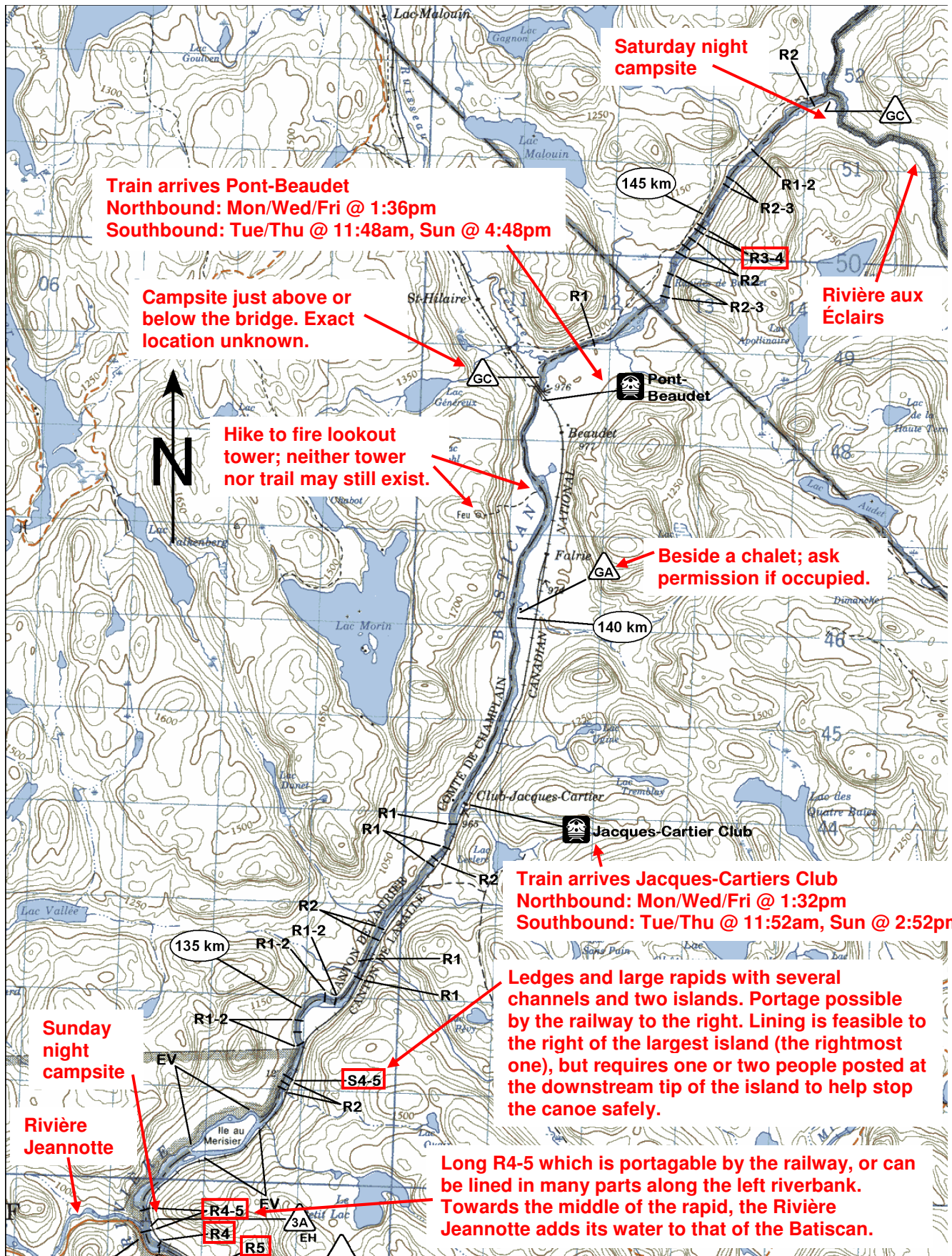

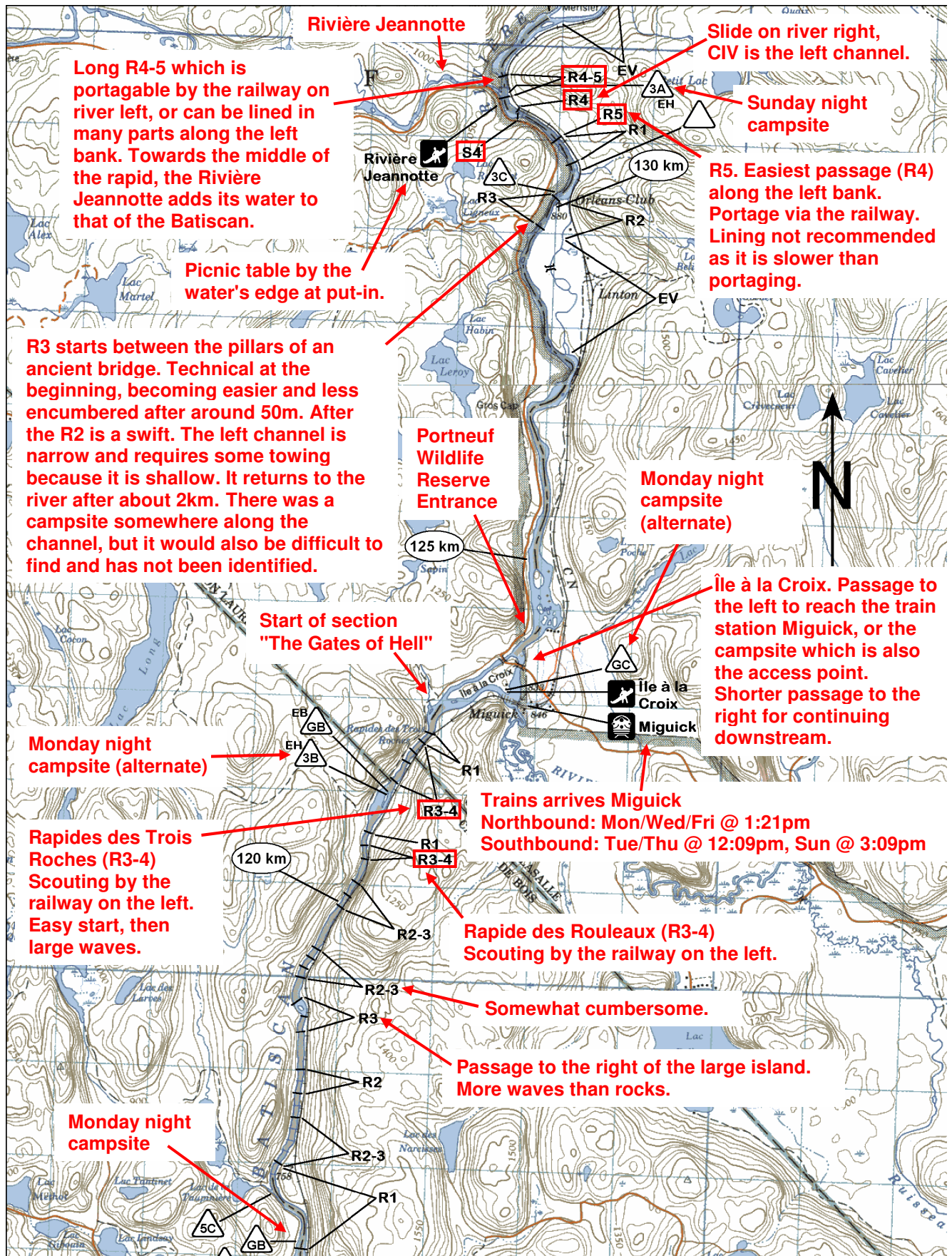

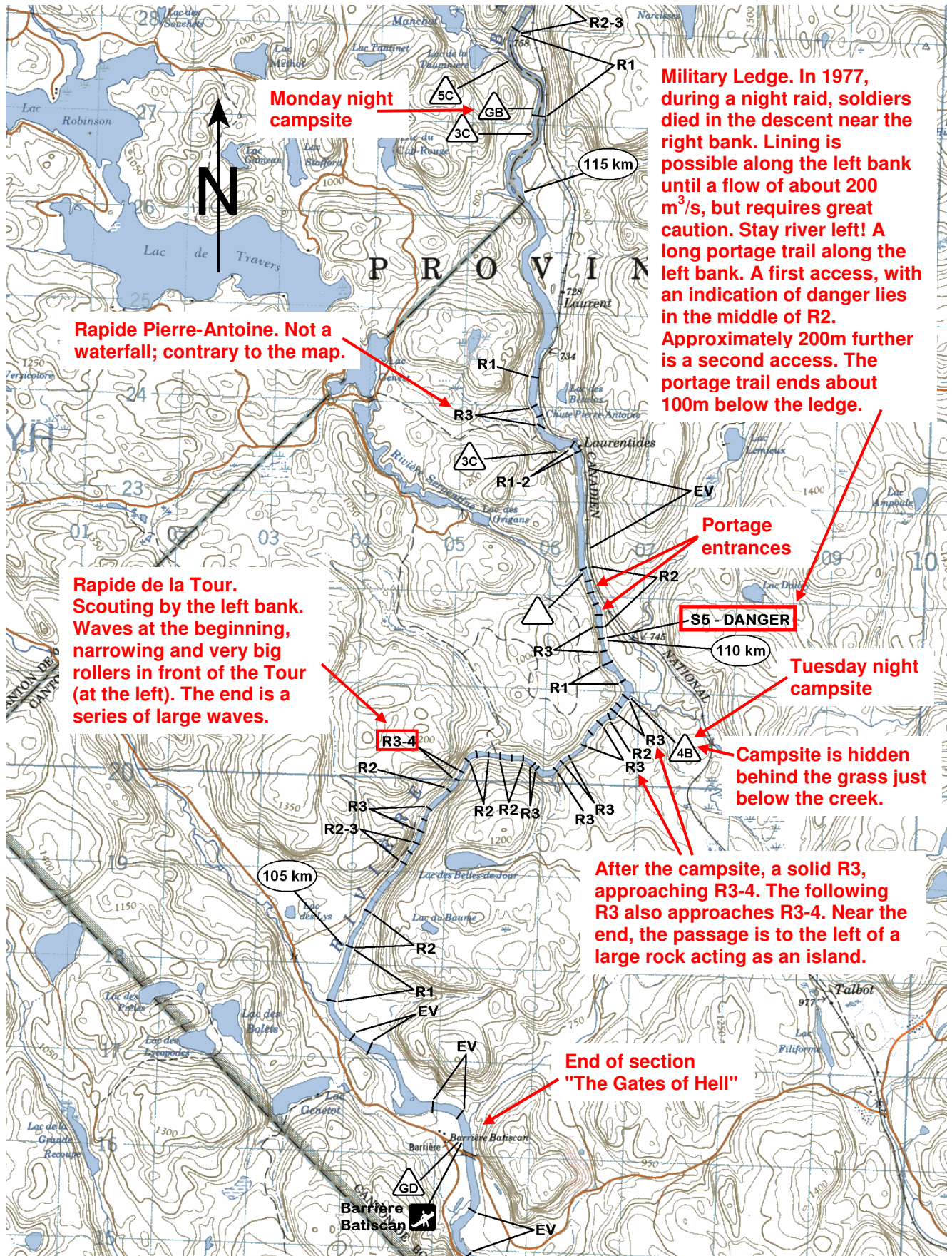

Military Ledge. In 1977, during a night raid, soldiers died in the descent near the right bank. Lining is possible along the left bank until a flow of about 200 m³/s, but requires great caution. Stay river left! A long portage trail along the left bank. A first access, with an indication of danger lies in the middle of R2. Approximately 200m further is a second access. The portage trail ends about 100m below the ledge.

Rapide Pierre-Antoine. Not a waterfall; contrary to the map.

Rapide de la Tour. Scouting by the left bank. Waves at the beginning, narrowing and very big rollers in front of the Tour (at the left). The end is a series of large waves.

Portage entrances

S5 - DANGER

Tuesday night campsite

Campsite is hidden behind the grass just below the creek.

After the campsite, a solid R3, approaching R3-4. The following R3 also approaches R3-4. Near the end, the passage is to the left of a large rock acting as an island.

End of section "The Gates of Hell"

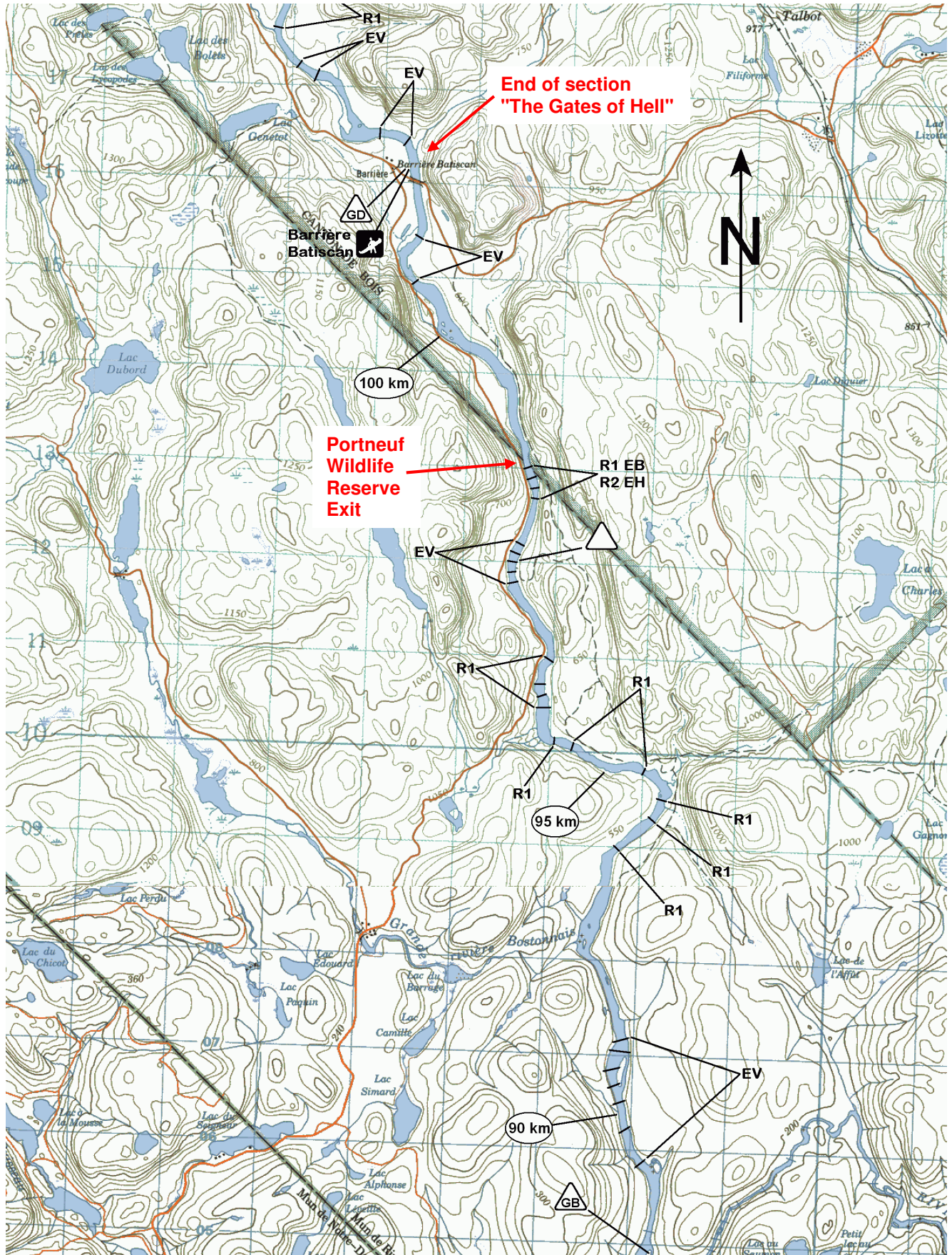

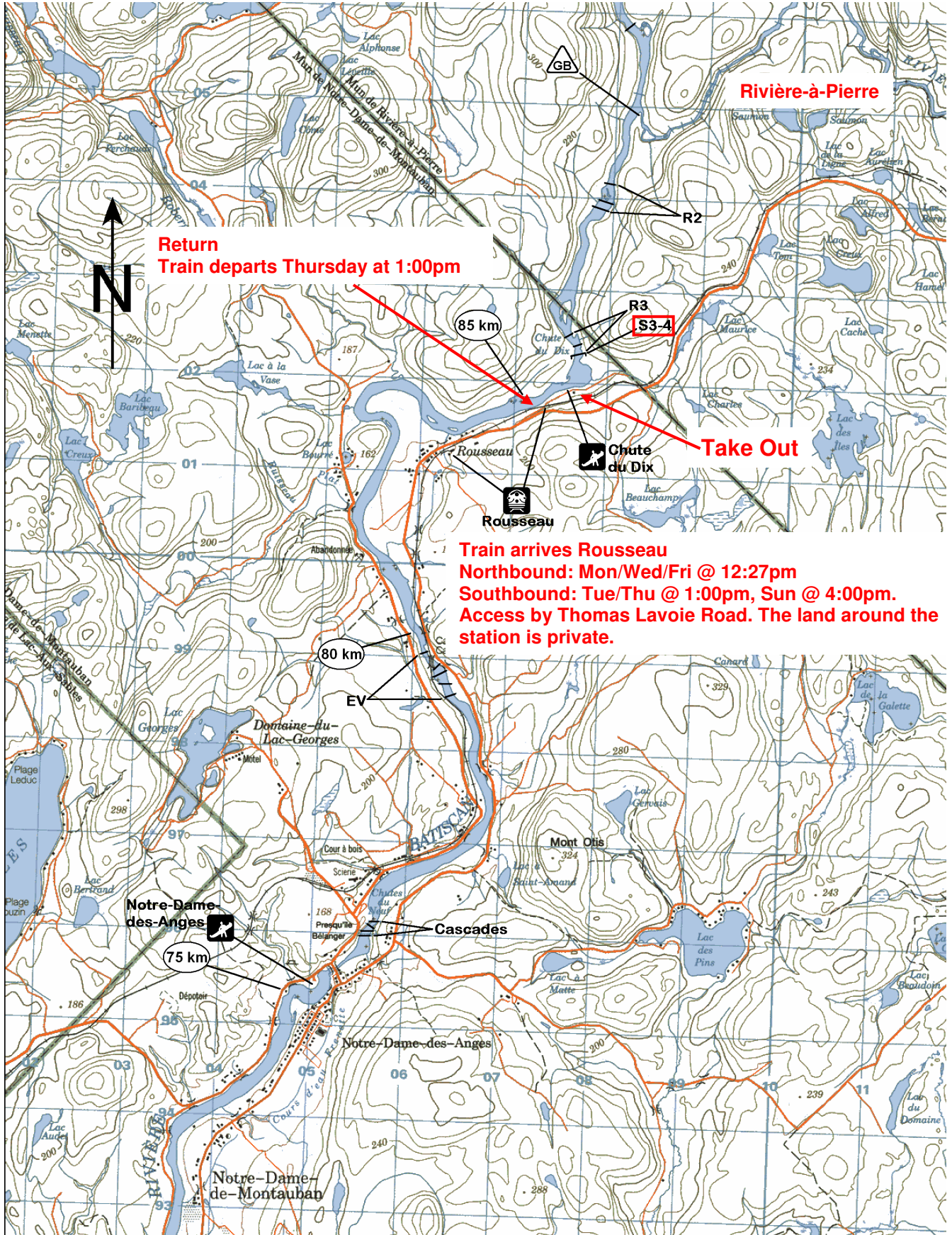

Report

Most people were able to show up the night before departure for our equipment and food packing. Even Bob showed up to see us off! With one less canoe than planned we had to take two less barrels, but we managed to cram everything in. A few things started off in dry bags to be later moved into barrels as food was eaten.

We departed on time at 6:00pm, arriving at ~10:00pm at the campground in Joliette. This place is more a seasonal trailer park, but we were placed in a large field beside a dining shelter. The shelter even had lighting. Ben and Alex couldn't wait to try the creek kayak, so they had it out that night in an adjoining pond; playing around a fountain.

The next morning we had our last hot shower. Breakfast was at Tim Horton's with a nice cup of coffee. Many of the kids went back for second helpings of food; that should have been the warning sign for our food supply. We arrived at the train station at least 1 1/2 hours before the train was scheduled to depart; the staff hadn't even arrived to unlock the gate. We unloaded all our gear and piled it beside the platform entrance. We hung around the waiting room for ages; the train was about an hour late. We placed the playboat inside a canoe as planned, but the staff didn't bother to correlate our reservation with the number of canoes we loaded.

The train ride was relaxing, but the carriages were actually quite full. A whole pile of students heading to a school in Jonquiere to learn French. Poor Gregory was stuck in a seat beside something. We were never quite sure whether the humanoid was a he, she, or an it :) The train was split in two at Hervey Junction. While we brought a couple of packs of playing cards, they were buried in a barrel, so Ben purchased a set of VIA cards and him and Adam played games and built houses. Two other canoe parties embarked on the train at various points. One was heading to Miquick and the other to Jacques-Cartier Club. I chatted the most with the group heading for Jacques-Cartier Club. They were from the Montreal Canoe Club. The trip leader had canoed the Batiscan many times. They were scheduled for the Lievre River, but came to the Batiscan as the Lievre had no water. Both groups were only doing 2-3 days trips over the weekend. They said they knew of a group that ran the full length of the river 1-2 weeks previously, and they reported that the job of the bow man was to lean over the bow and move rocks out of the way so the canoe could get down the river. Little did we know how much truth there was to that story... The quality of the food on the train was atrocious; specifically the subs were soggy. The menu didn't match the one we had obtained online.

As we closed in on our "station", Stew and I were ushered into the baggage car to ensure none of our equipment was left on the train. All the doors were open, so it was neat to see the scenery rushing by; though any barrel could just roll out a door at any time. When the train stopped, there was not only no station, but not even a post marking the spot. We tossed out all our equipment and the train rolled off, leaving us standing in the middle of track. We were past the point of no return. Stew had placed some pennies on the track, and had thus collected some squished copper as the train departed.

We tossed everything in the canoes and paddled upstream about 500m to our campsite. The site was very nice and large, but all sand. Those kids who had camped on sand before were not impressed, as they knew it got into everything. We found Stew had brought along a full size camp chair; we were jealous.

This was firework night to celebrate Canada Day. We made a pretty good display. Most of the fireworks had been placed in a dry bag, but one box didn't fit and it was left in kayak. It got wet; and we naturally blamed Alex :) Only the first few of 100 mortars in that item went off. The kids had fun pulling it apart to set the remaining ones off separately. Some had no fuse so they were thrown in a campfire; pointed away from us naturally. Stew wouldn't let the kids use the main campfire. They had to build a separate fire at the other end of the campsite. The next morning Stew picked up all the remaining pieces on the

sand, threw them in our main campfire, didn't tell us, and sat back in his chair and smiled as they went off around our feet!

The first two days were brutal. We had to drag the canoes through every rapid. There wasn't enough water to float a rubber duck. We were doing 15km per day with 7 1/2 hour days. We were all exhausted. Stew said later it was enough to put him off canoeing for ever. As we moved further down the river the water levels picked up and we were able to start scraping through. As Stew said, the rapids were so technical you not only needed to watch where your canoe went, but where your paddle went too! The last rapid on the river had the most water, and finally some decent sized waves, so we were all able to end on a good note. From looking at the rocks, and trees perched on rocks, our heads were below the normal surface of the water. However, from looking at the rock formations in the rapids, they would be wickedly nice at good water levels.

About half way down the river we realised we had been underestimating the difficulty of the rapids, and they can be a lot harder in many ways at low water with small channels to find and so many rocks to get pinned against. Stew is an excellent sternsman, and it was like a slalom course going down the river.

Stew really knows his birds and animals. He could name any bird just from its song. Not that we had the knowledge to call him on any of it. The only drawback was that if a bird flew by while we were canoeing, the canoe would veer off course as Stew checked out the bird :) We found a government fish trap at the mouth of one of the rivers that was obviously not being checked. It contained three dead and two live Speckled Trout. We tried to release the live fish, without success, as we didn't have the proper tools (dip net or wire cutter) on us. The kids did spot and identify a Bald Eagle which Stew missed.

Poor Gregory and dropping things. He started with dropping his supper, a slice of pizza, in the garbage can in the truck. We only have video proof that he threw away his paddle in a rapid once :) But he did spill half our Black Forest cake Dream Whip topping on Ben's foot!

Like always, I brought with me a number of books; I like to read before I go to sleep. Stew made a comment on the first evening about wishing he had a book to read, so I dug my selection out. During the week he made it through two trilogies: Tripods (John Christopher) and Smiler (Victor Canning). Next thing we knew, we had Adam and Gregory after the books, so we taught them to read too :)

The funniest rapid was a CIV slide. There wasn't enough water to run it in a canoe, but we dragged the canoes up the bank to scout it out. One of the canoes came loose and went flying down the slide, spinning around, dropping over ledges, and finally shot its self still upright into an eddy at the bottom. It was quite the sight to see, and we got it on video! Adam was at the bottom so he swam out to the canoe, but then found there were no paddles in it. So Alex, it could only be him, tossed a paddle down the rapids which shoots away from the canoe, so Adam dives back in the water to get the paddle, then swims back to the canoe :) Alex and Ben took a couple of runs each down a chute beside the slide. Ben said it was the best fun he has ever had in a kayak, with water cascading over his back on the way down.

One CIV look dicey, but Adam wanted to run it, so we stationed appropriate downstream safety, and he and Ben made a perfect run. The only other person who wanted to try was Jennifer. So her and Ben had a go. Unfortunately their line was not as good and their canoe flipped on the first drop. They were both quickly flushed out, after a couple of largish drops (Ben said it wasn't fun), but the canoe got stuck in a vertical pin. We only thought that happened with kayaks. A radio was ferried across the river to allow us to coordinate the rescue. We didn't have a waterproof bag for the radio, so we used one of the map cases. A throw bag rope was lassoed around the end of the canoe. Then it was pulled towards the bank, rolling the canoe, and the canoe popped right out of the pin and floated free. In parallel the other kids

were portaging the remaining canoes and gear around the rapid. This rapid had a really sketchy plank to walk across to get to the main viewing area.

Ben was surfing in one rapid when he flipped. As the river was shallow and full of rocks, his head collided with a rock. There wasn't enough water to roll, but he was able to push himself upright. The helmet took the main force, with the brim actually being chipped, but the rock also got the side of his face giving him a nice goose egg on his forehead and some abrasions. His good looks would be spoiled for the rest of the week :(New rule: no surfing if there are downstream consequences.

Stew and I pinned our canoe in a CII rapid. We became hemmed in between rocks, and though we tried really hard to prevent ourselves being broached (we leaned into the rock), we eventually took too much water over the gunwale. This time we needed our 150' rope. This was ferried up to us and taken to shore. One everybody started pulling in the right direction the canoe slid off the rocks. Stew and I were left stranded in the middle of the river, so we had to jump in and swim across the current to get ourselves to shore.

We had one last canoe pin. Ben and Adam were running a rapid and they went over a ledge. There was so little water that the canoe was left perched high and dry while they continued to paddle :) As they tried to jiggle it forward they flipped the canoe, they were ejected into the water, and the canoe got pinned. Once they managed to lasso the stern with a throw bag the canoe came off quite easily.

The river safety course we ran was definitely beneficial. Many times the kids were leaning downstream into rocks to prevent being broached, and they told us the rapid swimming instruction came in very handy making them a lot more comfortable in the water. The lining practice also paid off, with a lot of good work being done. I would only say the kids need to get more comfortable giving the canoes more freedom and be willing to let one rope go when appropriate. Lining ropes longer than our 25' would have helped at times.

Having two radios was very valuable for coordinating rescues over the noise of the rapids. One in each canoe and water proof cases would have been nice. They were also good for communication between the two cars during the commute to and from Joliette.

Ben and Adam did all cooking again, and an excellent job it was. However, that does take away the opportunity for the other kids to learn. Something we need to possibly re-think in the future. Again we should think about a duty roster for things like camp cleanup, water fetching, washing, etc so we are not continually having to assign tasks while trying to keep the work spread fairly among everybody.

Alex spent nearly the entire trip in a kayak, either the playboat or the creek boat. He just loves kayaks. Last year Alex soled a canoe a lot so Ben could be in a kayak, and this year Adam soloed nearly the entire last couple of days so Alex could be in a kayak. It was actually very handy having Alex in a kayak at the bottom of a rapid as a safety boat. Several times he went off after canoes, barrels, and packs floating downstream. As the rapids were so small, we didn't bother tying down the gear most of the time. One time Gregory and Calvin swamped Stew's and my canoe while lining it down a rapid and two barrels went merrily downstream. Alex flew after them, catching one pretty quickly but by the time that he had that on shore, the other was out of sight. He caught up with it after about a kilometer. He then hiked back up the shore to rejoin us. The creek boat we rented from Paddle Shack, due to our odd number, worked out fine. It carried our shelter poles behind the seat.

Alex got it into his head that he wanted to teach people the kayak roll. So he started the first night and kept at it most evenings. He taught Ben the back deck roll (Alex had taught himself from YouTube) then he taught Max a regular roll (Max was in seventh heaven). He worked with Adam and Jen, but they weren't able to master it. Alex couldn't get the hand roll from Ben though. I showed people that I still had

my roll. Alex quipped "Now I believe you!". Later he swims up to me and asked how many times I had rolled, I told him I was three for three. He then promptly flips my kayak over! When I roll back, he says "Now you are four for four!". When running one rapid in the kayak Alex flipped and he rolled back so quickly the deck hardly appeared to get wet.

On the last night we had a great campsite. It was on a point of land with another river down one side with a set of small rapids. The kids spent hours playing at the bottom where this river met the Batiscan. There were large rocks going into the water to lie on, they took one of the now empty barrels and shot the rapids with it, and lots of swimming, canoeing, kayaking, and general horsing around.

This campsite was only about 4km upstream from our takeout. Since we were about out of food, some of the lads (Alex, Ben, Adam, Gregory) decided to see if they could hike into Rousseau and find a corner store. They set out at 7pm intending to just follow paths we saw leading from our campsite. At 10:45pm Max woke me up, I had fallen asleep in Ben's hammock (when they left I heard a "Allan had better not be asleep in my hammock when I get back"). The lads weren't back and it was pitch black. I woke Stew and we were just discussing what action to take, when the four of them turned up walking along the river edge. They made it to Rousseau by the paths, a little bush whacking, and following the river's edge. Upon arrival in Rousseau, they couldn't find a store, so they asked and were told the closest one was another 8km downstream at the next village. It was about a 12km round trip hike for them. Ben brought a flashlight, but they didn't have any other equipment (like a map, compass, and more flashlights). They had set themselves a time to turn back, but ignored it. We also didn't set a time for which they had to be back at camp. They could also have taken a radio which would probably have reached to Rousseau. A learning experience for all.

For the first time in my camping history we actually ran out of food. All we had left were a couple of bags of cold cereal. Stew was the only one with any food left, and that was because he brought his only supply of gluten free items. The kids tried some of his bread, but declined on the second offering :) Our second last lunch was two Ritz crackers, 1/2 a pita, peanut butter & cream cheese. We did still have a proper supper. The last lunch, just before we boarded the train, was peanut M&Ms and brownies :) While some of our breakfast/lunch quantities were evidentially a little low, the main issue was more English muffins and bagels were toasted for breakfast than planned; they were mostly intended for lunches. We also forgot to factor in the tortillas required for the pizza, so some lunch tortilla wraps were used.

The new type of "nutritious" pop tarts were not liked. We took too much cereal. Needed more English muffins and bagels and jam. The squeeze tubes for the jam (2), mustard (1), and horse radish (1) worked really well. They loved the salmon croquets again; could have made about 50% more. The garlic bannock biscuits baked in the Outback oven were really good. We baked them all for the first supper. All the cookies I made went down well. The real Fettuccini with whipping cream and parmesan cheese was much preferred over the package we used last year. The freezer barrel we made kept our food colder for longer this year. The Black Forest cake we baked turned out really well. The Dream Whip topping didn't really whip even after sacrificing our four cold packs from the first aid kits to try and cool it down. People were told not to injure themselves after that :) But they did... The red apples became uneatable before they were all eaten, the green apples survived much better. Three heads of lettuce was right. We ran out of juice crystals, Iced Tea, again, even though we took more this year. Not sure if this was because people liked it better or whether we were drinking more due to the heat. The Rice Krispies didn't get touched until we ran out of all the other food; we only brought them because Stew thought he could eat them (he couldn't). We were amazed at how much and how fast Gregory could eat. He was timed at 14s for a taco! The pizzas that were to be cooked over the campfire, were actually mostly cooked in the Outback oven. That worked very well, though it took some time to do each one.

At km 140 on the river, there is a campsite marked on the map as "Beside a chalet; ask permission if occupied". When we reached that point, sure enough there was a chalet (and a couple of men) but no

sign of a campsite. We canoed up to them and asked, in French of course, if there was a campsite. Once we said we were Scouts, we were welcomed with open arms. It turned out they knew about the map showing a campsite, but one did not exist. However, since we were Scouts we were more than welcome to camp on their lawn. No cost, all they asked for was our respect. We could make our own campfire if we wanted, or we could come sit by their campfire. The younger fellow called across to a friend of his at the next chalet, inviting him over to see the "gang of Scouts" he had staying with him :) This was the night the kids made the Black Forest cake, so they took over a couple of slices as a thank you. These guys took my email address because they wanted copies of the photos so they could show people the Scouts that stayed with them. They told us this was not a public campsite, but that we were welcome to camp there anytime. I will be asking the map owner to remove this campsite from his map. At this campsite two mountains could be seen, one was called Indian Face and the other Sleeping Giant; you can guess what they look like.

In Joliette and on the river, nearly everyone was unilingual French speaking. This was good practice for me, but Stew was also speaking French as was Ben. Good for all!

One day we saw a pickup truck trundle down the train track beside the river. A bit later it headed back in the other direction. It stopped and a guy walked down the embankment to the river looking at us. I started to think he was part of a search party or something. We made our way over, and it turned out he was a whitewater canoer and just wanted to chat about our trip and tell us about the trips he has done. Another day a train whistled to us as it passed.

The last rapid, right before the takeout had an old guy surfing in an inflatable kayak at the bottom. He was nice and laid back, drinking at least two bottles of beer from a cooler while we were there. The kids were impressed with his one handed rolling of cigarettes while kayaking. He said he owned about five different kayaks and did a lot of whitewater paddling. When our canoes ran the rapid, he would sit at the bottom and stick up his paddle showing us the right line to take. He tried to direct us right into Rousseau for the takeout, but we kept to where it looked right on the map, and the knowledge of our advanced scouting party from the night before :)

It was only a 200m walk from the takeout to the train tracks. Adam managed to get a nice juicy leech on his ankle. We baked brownies for lunch. Adam laid out a whole row of pennies on the track for the train. About half an hour before the train was due we heard a train coming, so we scrambled to get ready. It turned out to be just a freight train. Ben and Adam had started eating the brownies right out of the pan before they were done as they thought we would have to jump on the train!

With no weather forecasts, naturally the heat wave hits us unexpectedly. Canoeing all day with the wind off the water and being in the water half the time, we didn't notice anything until we stopped to camp for the night. Then the kids exclaimed "What is the temperature?". So I hauled out my thermometer and found it was 33C! For the next couple of days when we reached our campsites the kids basically rolled out of the canoes into the water and played for the next few hours. They didn't even carry their kit into the campsite and think about making supper until 6-7pm. With the thermometer out, it brought with it the inevitable competition as to how could blow the fastest (the unit has an anemometer). Max always wins.

Rather than the barrel bags from last year, we tried keeping our small items in two transparent vinyl pouches; these worked much better. The larger screened dining shelter was very nice. However it only has mosquito netting and thus lets through sand flies. It did make the first few days of the trip a lot more pleasant. The black flies were bad at the top of the river, but we had less trouble as the week wore on.

One day we stopped for lunch at a cute little cabin, sheltering under its front porch. The best feature it had though, was an outhouse with a padded seat!

The train ride home was a dream. Air conditioning, ice cold drinks, and food (microwaved cheese burgers). This is definitely the way to shuttle. It was about an hour late picking us up, and an additional 1/2 hour late arriving in Joliette. We all got to go in the baggage car, with it's open doors, as we approached Joliette. After packing up the trucks and canoe trailer, we decided to go to Dairy Queen as it was roasting hot again. We received directions from a guy at the station, but we made a wrong turn, and headed the wrong way down a one way street. A sweet reversing job, according to the kids, with the canoe trailer, and all was fixed. Allan made it to Dairy Queen first, the guy from the station actually followed us to make sure we found it, and guided Stew in by radio.

We did much better preventing equipment loss this year. We only lost two paddles and bent one beyond repair. One skid plate had chunks taken out of it. This was one installed (poorly) by the manufacturer, not one of the replacements Ben and I installed this past winter. We still have materials for one more install, so we will get that replaced.

The repair kit got a lot more use. Jennifer sewed a tear in the screen of one of the hammocks; she wouldn't let me do it :) Gregory's water shoes came apart and we attempted to epoxy (5 minute) them back together. It lasted for a while but then came apart. Shoe Goo might have done a better job. Ben's sleeping bag was missing it's zipper, so I put it back together with 37 safety pins! They were collected from both our two repair kits and our two first aid kits. Stew's chair fell apart and that was wired back together.

Calvin made good use of the after burn cream in the first aid kit. He also had wicked tan lines on his arms from using fingertip less paddling gloves. Many of the kids used the anti-itch wipes (benzocaine). We also had a variety of cut fingers and scraped legs.

Our start and end times each day:

Saturday: 8:45am - 5:00pm
Sunday: 9:15am - 4:30pm
Monday: 9:30am - 6:00pm
Tuesday: 9:15am - 3:00pm
Wednesday: 10:00am - 3:15pm

In spite of the low water and lack of large rapids the kids said they enjoyed the trip. Ben, Jen, and Adam have all expressed an interest in a canoe trip again next year even though they will not be in Venturers. Ben will supposedly be concentrating on school, and Jen and Adam are both off to college/university.

The equipment dispersal upon our return worked well. Sending the barrels home with people was easier and less time consuming than dealing with them.

Station : 050304 - Batiscan - à 3,4 km en aval de la rivière des Envies (Débit moyen en m³/s)

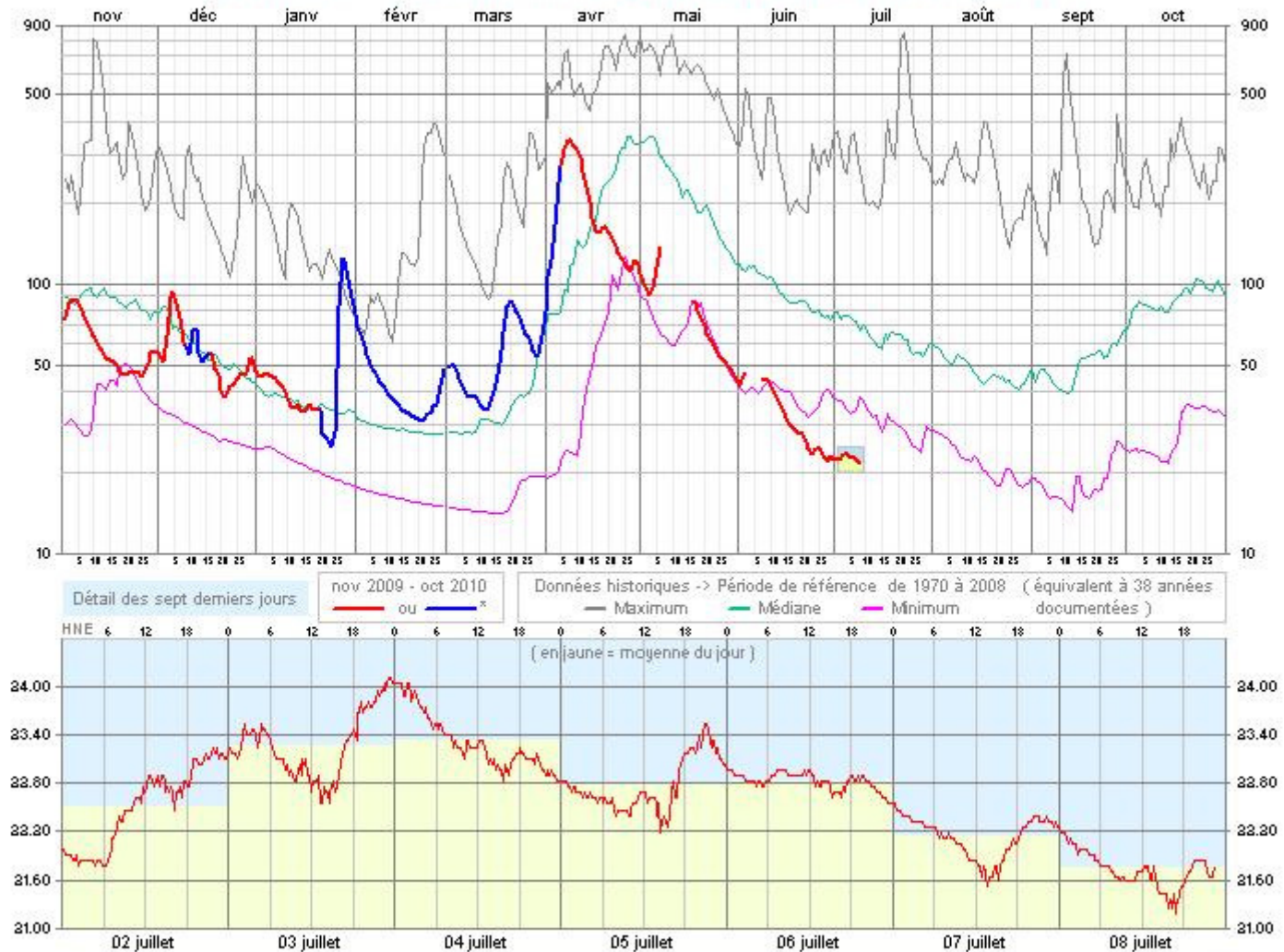

Note : Les données récentes sont préliminaires et sujettes à modification après validation.

* Les débits sont, soit corrigés pour effet de refoulement, soit estimés.

Produit le 2010-07-08 à 23:55